

RailRoad Lite.



furnitubes
shaping outdoor spaces





RailRoad Ranges.



RailRoad
**Integrated seating
and planters**

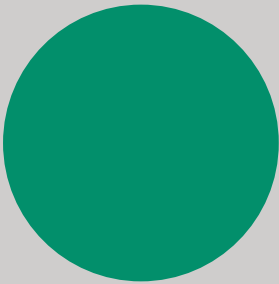

RailRoad
**Inline seating
and benches**



RailRoad
Lite



RailRoad
Tables

RailRoad Lite ●

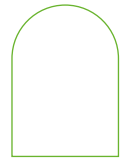
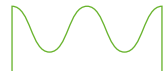

Compact, cost effective benches

The RailRoad Lite bench range is an ideal solution where seating is only required for one person at a time.

At a width of up to 495mm, benches are for single sitting meaning two people are not able to perch on either side as with standard RailRoad benches.



Standard RailRoad bench allows perch seating from both sides

Lite bench suits one person on each part at any one time

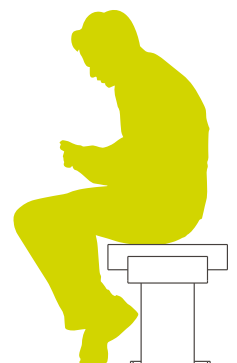

How is it different?

As our cost-effective solution to the Railroad range, Railroad Lite is a bench-only seating solution with a 450 - 475 - 495 wide timbers. However with the same mechanics as the original range, Railroad Lite still offers flexibility and style in abundance.

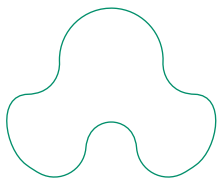
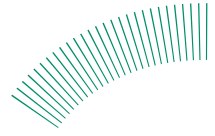

How does it work?

RailRoad Lite is based on a simple series of inter-changeable straight and curved modules, which are designed to be joined to create seamless runs of continuous seating. The design is based around a standard module

that comfortably accommodates 2 people, with the start and end units also including small extension sections at one end. Just like train tracks, straights and curves can be mixed to create interesting configurations.

Standard dimensions: Straight 2-person module

Key:
(both diagrams)

Shaded boxes indicate standard armrest positions

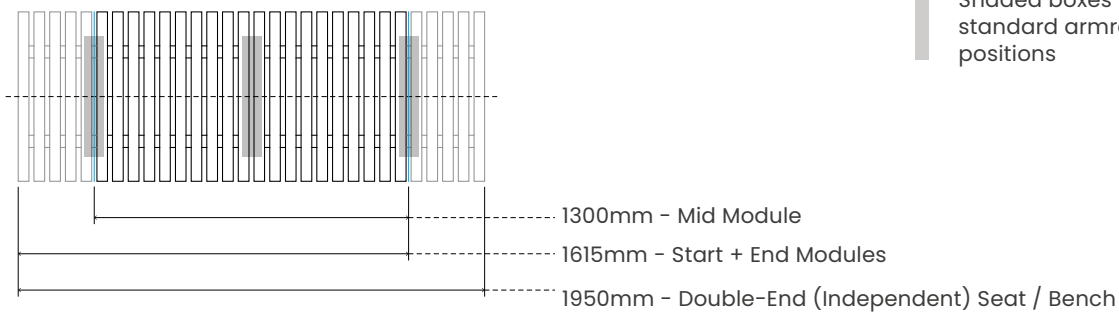

End modules have an extension with 5 additional timbers on one side and are reversible

Standard dimensions: Curved 2-person module

STANDARD RADIUS OPTIONS

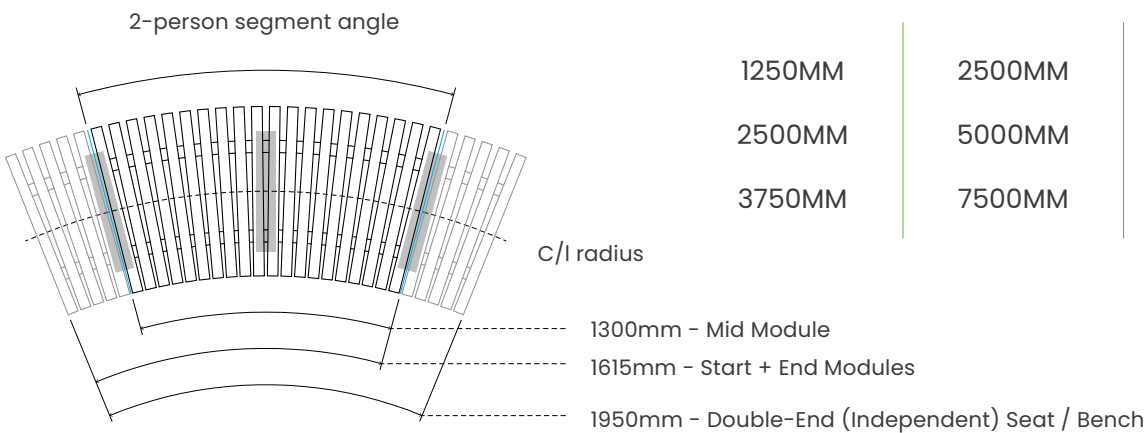

CENTRE LINE RADIUS	CENTRE LINE DIAMETER	2-PERSON SEGMENT ANGLE
1250MM	2500MM	60 DEG
2500MM	5000MM	30 DEG
3750MM	7500MM	20 DEG

Left hand end modules have an extension with 5 additional timbers on the left hand side

Right hand end modules have an extension with 5 additional timbers on the right hand side

Note: dimensions are arc lengths along centre lines and are common to all seat radii options (segment angles vary with radius)

Seating.

There are 3 styles to choose from in the Railroad range, Delta, Loop and Edge. Each style has a corresponding end profile detail of the timber slats and the seating supports.

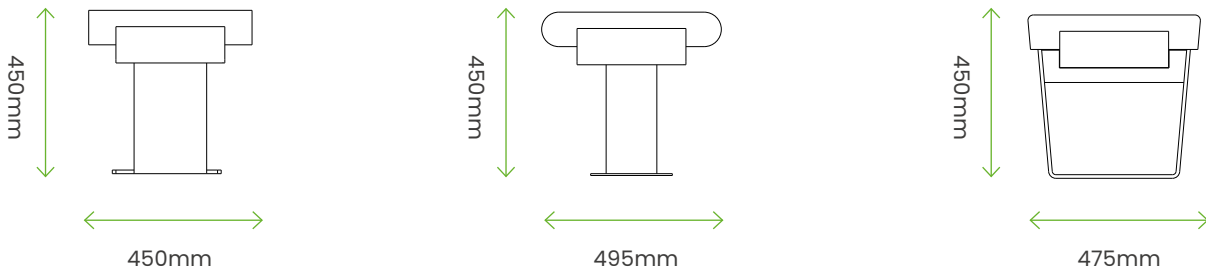

Edge

Square-form timbers define the sharp visual characteristics of the EDGE family, making this range a popular choice on new developments. The support posts are in a complementary open-ended box fabricated in plate steel that gives a heavy duty, robust aesthetic.

Loop

The distinctive rounded end profile of the bench slat is reminiscent of a lollipop stick, hence the abbreviated LOOP name given to this family. The central circular post supports are visually less obtrusive and softer than both the Edge and Delta options.

Delta

Although made of heavy duty steel bar, the open frame support of the DELTA is visually less heavy than the other options. The vertical faces are tapered back towards the ground to give the distinctive delta form in side profile. Timber slats are square-ended as used for the Edge option.

General specification

Steel frame & seat supports for bolt-down surface fixing, triple processed, with iroko timber seat slats.

All 3 standard RailRoad styles – Edge, Loop and Delta – are offered in straight versions and 3 curved sizes in the RailRoad Lite range of products. The design principles and geometry remain as for the standard width bench, allowing all the same interchangeability and configuration layout options from simple straight lines to circles, horseshoes and wave-forms.

Options

- Extended depth supports for in-ground installation (not Delta)
- Armrests – all-steel or steel with iroko topvv
- UV protective finish
- Square-ended 'Edge' timber slats with Loop & Delta supports

Straight benches.

Straight bench platforms + Edge supports

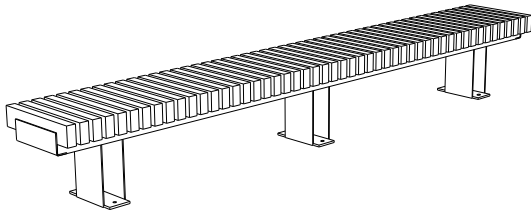

model illustrated:
RRBESN S + RRBESN E (3250mm long)

START MODULE
1650MM LONG
(INCL 2 SUPPORTS)
RRBESN-S-TP

END MODULE
1615MM LONG
(INCL 1 SUPPORT)
RRBESN-E-TP

MID MODULE
1300MM LONG
(INCL 1 SUPPORT)
RRBESN-M-TP

INDEPENDENT BENCH
1950MM LONG
(INCL 2 SUPPORTS)
RRBESN-1950-TP

Straight bench platforms + Loop supports

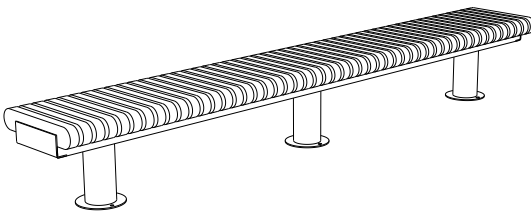

model illustrated:
RRBLRN S + RRBLRN E (3250mm long)

START MODULE
1650MM LONG
(INCL 2 SUPPORTS)
RRBLRN-S-TP

END MODULE
1615MM LONG
(INCL 1 SUPPORT)
RRBLRN-E-TP

MID MODULE
1300MM LONG
(INCL 1 SUPPORT)
RRBLRN-M-TP

INDEPENDENT BENCH
1950MM LONG
(INCL 2 SUPPORTS)
RRBLRN 1950-TP

Delta Straight bench

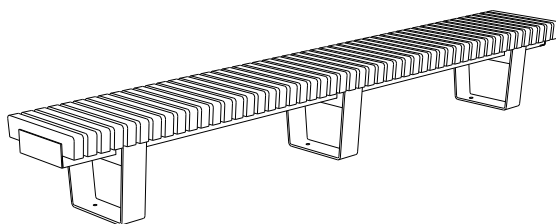

model illustrated:
RRBDAN S + RRBDAN E (3250mm long)

START MODULE
1650MM LONG
(INCL 2 SUPPORTS)
RRBDAN-S-TP

END MODULE
1615MM LONG
(INCL 1 SUPPORT)
RRBDAN-E-TP

MID MODULE
1300MM LONG
(INCL 1 SUPPORT)
RRBDAN-M-TP

INDEPENDENT BENCH
1950MM LONG
(INCL 2 SUPPORTS)
RRBDAN-1950-T

Curved benches.

Curved bench platforms + Edge supports

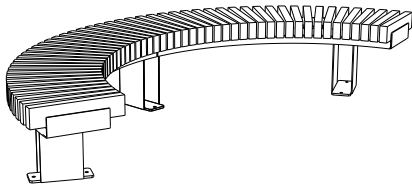

model illustrated:
RRBESN-SR125 + RRBESN-EL125
(3250mm c/l radius)

**START MODULE LEFT HAND
1615MM LONG (INCL 2 SUPP)**

**START MODULE RIGHT HAND
1615MM LONG (INCL 2 SUPP)**

**MID MODULE
1300MM LONG (INCL 1 SUPP)**

**END MODULE LEFT HAND
1615MM LONG (INCL 1 SUPP)**

**END MODULE RIGHT HAND
1615MM LONG (INCL 1 SUPP)**

**1950MM LONG INDEPENDENT
BENCH (INCL 2 SUPP)**

R1.25M C/L

R2.50M C/L

R3.75M C/L

RRBESN-SL125-TP

RRBESN-SL250-TP

RRBESN-SL375-TP

RRBESN-SR125-TP

RRBESN-SR250-TP

RRBESN-SR375-TP

RRBESN-M125-TP

RRBESN-M250-TP

RRBESN-M375-TP

RRBESN-EL125-TP

RRBESN-EL250-TP

RRBESN-EL375-TP

RRBESN-ER125-TP

RRBESN-ER250-TP

RRBESN-ER375-TP

RRBESN-125-TP

RRBESN-250-TP

RRBESN-375-TP

Curved bench platforms + Loop supports

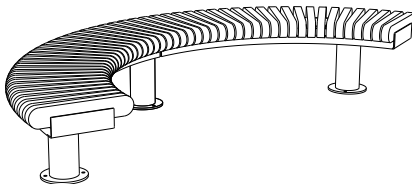

model illustrated:
RRBDAN-SR125 + RRBDAN-EL125
(3250mm c/l radius)

**START MODULE LEFT HAND
1615MM LONG (INCL 2 SUPP)**

**START MODULE RIGHT HAND
1615MM LONG (INCL 2 SUPP)**

**MID MODULE
1300MM LONG (INCL 1 SUPP)**

**END MODULE LEFT HAND
1615MM LONG (INCL 1 SUPP)**

**END MODULE RIGHT HAND
1615MM LONG (INCL 1 SUPP)**

**1950MM LONG INDEPENDENT
BENCH (INCL 2 SUPP)**

R1.25M C/L

R2.50M C/L

R3.75M C/L

RRBLRN-SL125-TP

RRBLRN-SL250-TP

RRBLRN-SL375-TP

RRBLRN-SR125-TP

RRBLRN-SR250-TP

RRBLRN-SR375-TP

RRBLRN-M125-TP

RRBLRN-M250-TP

RRBLRN-M375-TP

RRBLRN-EL125-TP

RRBLRN-EL25-TP

RRBLRN-EL375-TP

RRBLRN-ER125-TP

RRBLRN-ER25-TP

RRBLRN-ER375-TP

RRBLRN-125-TP

RRBLRN-250-TP

RRBLRN-375-TP

Curved bench platforms + Delta supports

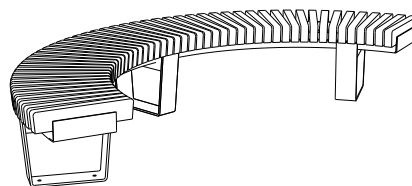

model illustrated:
RRBDAN-SR125 + RRBDAN-EL125
(3250mm c/l radius)

**START MODULE LEFT HAND
1615MM LONG (INCL 2 SUPP)**

**START MODULE RIGHT HAND
1615MM LONG (INCL 2 SUPP)**

**MID MODULE
1300MM LONG (INCL 1 SUPP)**

**END MODULE LEFT HAND
1615MM LONG (INCL 1 SUPP)**

**END MODULE RIGHT HAND
1615MM LONG (INCL 1 SUPP)**

**1950MM LONG INDEPENDENT
BENCH (INCL 2 SUPP)**

R1.25M C/L

R2.50M C/L

R3.75M C/L

RRDASN-SL125-TP

RRBDAN-SL250-TP

RRBDAN-SL375-TP

RRBDAN-SR125-TP

RRBDAN-SR250-TP

RRBDAN-SR375-TP

RRBDAN-M125-TP

RRBDAN-M250-TP

RRBDAN-M375-TP

RRBDAN-EL125-TP

RRBDAN-EL250-TP

RRBDAN-EL375-TP

RRBDAN-ER125-TP

RRBDAN-ER250-TP

RRBDAN-ER375-TP

RRBDAN-125-TP

RRBDAN-250-TP

RRBDAN-375-TP

Why Furnitubes.

- **Made in the UK**
our factory is based in Kent, so expect faster leadtimes and no supply chain delays
- **Easy to maintain + low labour costs**
we make sure that fixing points are easily accessible so slats and brackets can be changed easily when damaged
- **Modular solutions**
our ranges are modular and customisable, seating and planters can be easily combined, be creative without blowing the budget
- **Our approach**
we take a considered approach to design, it's not just about the end product. We take everything in the process into consideration, we are collaborative and we are committed to producing products that improve our environment & keep people safe.



Our Process.

- **Get in touch** – it's as simple as that, give us a call or drop us an email, we're happy to help whatever the medium!
- **Collaborate** – Depending on your needs, you might not actually need us at this stage, that's the beauty of our modular ranges – they're designed with you in mind, so you can specify with ease. Nevertheless, we are here for you if you do – our design team are always on hand to discuss the nitty gritty of your project.
- **Specification** – This is where our team of experts take the wheel and help you with sketches, CADs and more to help you specify our products as easily as possible.
- **Production + delivery** – all of our products are designed and manufactured in the UK allowing us to give you shorter lead times. With a dedicated project manager keeping you in the loop, you can trust everything is in hand.





Furnitubes



Furnitubes



Furnitubes International UK

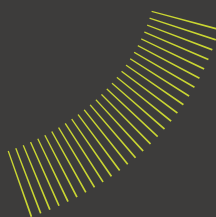

furnitubes
shaping outdoor spaces

T: +44 (0)20 8378 3200
E: sales@furnitubes.com
www.furnitubes.com