

AKRI Snap.



With minimal design time required and a guaranteed quick turnaround, AKRI Snap is built to green the grey in urban areas with a variety of seating and planter options.

Choose from standard planters with the option to add benches, armrests, seating, or cantilever solutions designed with the same attention to aesthetic and sustainability as our popular AKRI 300 and AKRI 600 ranges.

Materials and Finishes

AKRI Snap panels and seating components are made of 80% recycled mild steel, triple-process powder coated to a standard RAL. We have a carefully selected RAL colour palette for all our products, details available on request. Panels are available in Corten untreated. Seat and backrest are available in FSC certified Iroko wood slats or Endura® Thermally Modified Ash.



FSC Iroko



Iroko with UV
Protective Finish

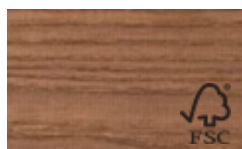

Endura® Thermally
Modified Ash

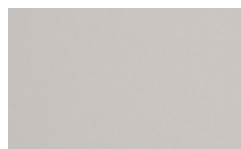

Triple process powder
coated steel to
standard RAL



Corten untreated

Furnitubes reserve the right to alter designs and dimensions at any time to improve our products. Please ensure that you have the latest issue of the document. Dimensions are given for information purposes only, all measurements are in mm and weights in KG unless otherwise stated. If dimensions are critical please contact our sales team. Document issue 1, date 29/07/2024.

AKRI Snap.

Panels - 300 h

AKRS3-30PL1

1 metre panel with 1 support



AKRS3-30PL2

2 metre panel with 2 supports

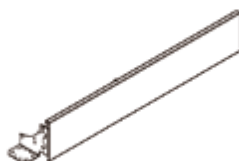

AKRS3-30CN1

Closed corner with 1 support



AKRS3-30CN2

Open corner with 1 support



		1000	300	300	12
AKRS3-30PL1	1 metre panel	1000	300	300	12
AKRS3-30PL2	2 metre panel	2000	300	300	24
AKRS3-30CN1	Closed corner	500	500	300	12
AKRS3-30CN2	Open corner	500	500	300	12

Furnitubes reserve the right to alter designs and dimensions at any time to improve our products. Please ensure that you have the latest issue of the document. Dimensions are given for information purposes only, all measurements are in mm and weights in KG unless otherwise stated. If dimensions are critical please contact our sales team. Document issue 1, date 29/07/2024.

AKRI Snap.

Panels - 500 h

AKRS3-50PL1

1 metre panel with 1 support

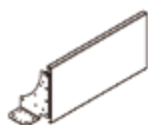

AKRS3-50PL2

2 metre panel with 2 supports

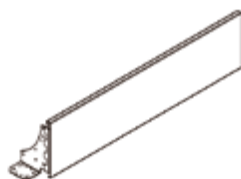

AKRS3-50CN1

Closed corner with 1 support



AKRS3-50CN2

Open corner with 1 support



AKRS3-50PL1	1 metre panel	1000	300	500	19
AKRS3-50PL2	2 metre panel	2000	300	500	37
AKRS3-50CN1	Closed corner	500	500	500	19
AKRS3-50CN2	Open corner	500	500	500	19

Furnitubes reserve the right to alter designs and dimensions at any time to improve our products. Please ensure that you have the latest issue of the document. Dimensions are given for information purposes only, all measurements are in mm and weights in KG unless otherwise stated. If dimensions are critical please contact our sales team. Document issue 1, date 29/07/2024.

AKRI Snap.

Panels - 800 h

AKRS3-80PL1

1 metre panel with 1 support



AKRS3-80PL2

2 metre panel with 2 supports

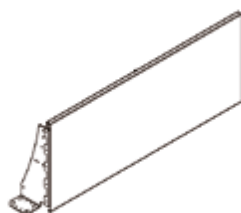

AKRS3-80CN1





Closed corner with 1 support



AKRS3-80CN2

Open corner with 1 support



					
AKRS3-80PL1	1 metre panel	1000	300	800	29
AKRS3-80PL2	2 metre panel	2000	300	800	58
AKRS3-80CN1	Closed corner	500	500	800	29
AKRS3-80CN2	Open corner	500	500	800	29

Furnitubes reserve the right to alter designs and dimensions at any time to improve our products. Please ensure that you have the latest issue of the document. Dimensions are given for information purposes only, all measurements are in mm and weights in KG unless otherwise stated. If dimensions are critical please contact our sales team. Document issue 1, date 29/07/2024.

AKRI Snap.

Seating - 500 h

AKRS3-50PB16-TP

1600 bench on 500h panel

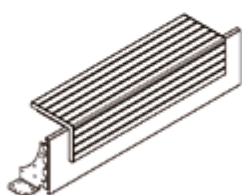

AKRS3-50PBA16-TP

1600 bench with end arms on 500h panel

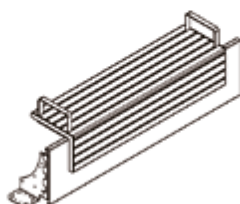

AKRS3-50PBAK16-TP

1600 seat with end arms on 500h panel

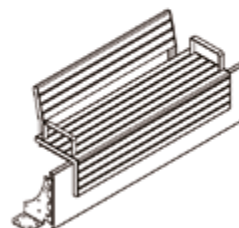

AKRS3-50PB20-TP

2000 bench on 500h panel

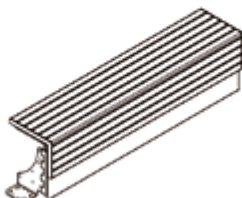

AKRS3-50PBA20-TP

2000 bench with end arms on 500h panel

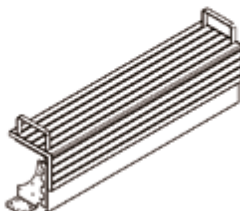

AKRS3-50PBAK20-TP

2000 seat with end arms on 500h panel

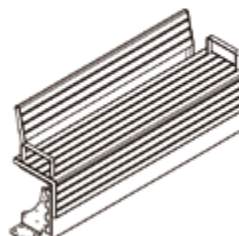

		1600	500	700	900	KG
AKRS3-50PB16-TP	3 person bench on 2 metre panel	1600	500	500	550	80
AKRS3-50PBA16-TP	3 person bench with end arms on 2 metre panel	1600	500	700	550	84
AKRS3-50PBAK16-TP	3 person seat with end arms on 2 metre panel	1600	500	900	550	95
AKRS3-50PB20-TP	4 person bench on 2 metre panel	2000	500	500	550	87
AKRS3-50PBA20-TP	4 person bench with end arms on 2 metre panel	2000	500	700	550	90
AKRS3-50PBAK20-TP	4 person seat with end arms on 2 metre panel	2000	500	900	550	105

Furnitubes reserve the right to alter designs and dimensions at any time to improve our products. Please ensure that you have the latest issue of the document. Dimensions are given for information purposes only, all measurements are in mm and weights in KG unless otherwise stated. If dimensions are critical please contact our sales team. Document issue 1, date 29/07/2024.

AKRI Snap.

Cantilever Seats & Trays

AKRS3-80CB16-TP

1600 wide cantilever bench on 800h panel



AKRS3-80CB20-TP

2000 cantilever bench on 800h panel

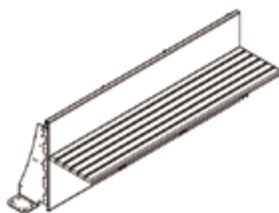

AKRS3-TR1





Large tray 1000 x 500



AKRS3-TR2

Small tray 500 x 500



						
AKRS3-80CB16-TP	3 person bench on 2 metre panel	1600	500	800	550	116
AKRS3-80CB20-TP	4 person bench on 2 metre panel	2000	500	800	550	120
AKRS3-TR1	Large galvanized tray 1000 x 500	1000	500	30	-	13
AKRS3-TR2	Small galvanized tray 500 x 500	500	500	30	-	7

Furnitubes reserve the right to alter designs and dimensions at any time to improve our products. Please ensure that you have the latest issue of the document. Dimensions are given for information purposes only, all measurements are in mm and weights in KG unless otherwise stated. If dimensions are critical please contact our sales team. Document issue 1, date 29/07/2024.

AKRI Snap.

Panels & corners. Parts supplied

The AKRI Snap planter wall system is supplied in component parts for on-site assembly. Wall panels are supplied with a protective plastic film on the external front face, which we recommend is left on until the whole wall system is installed and surrounding paving works are completed.

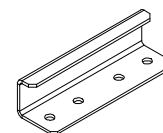
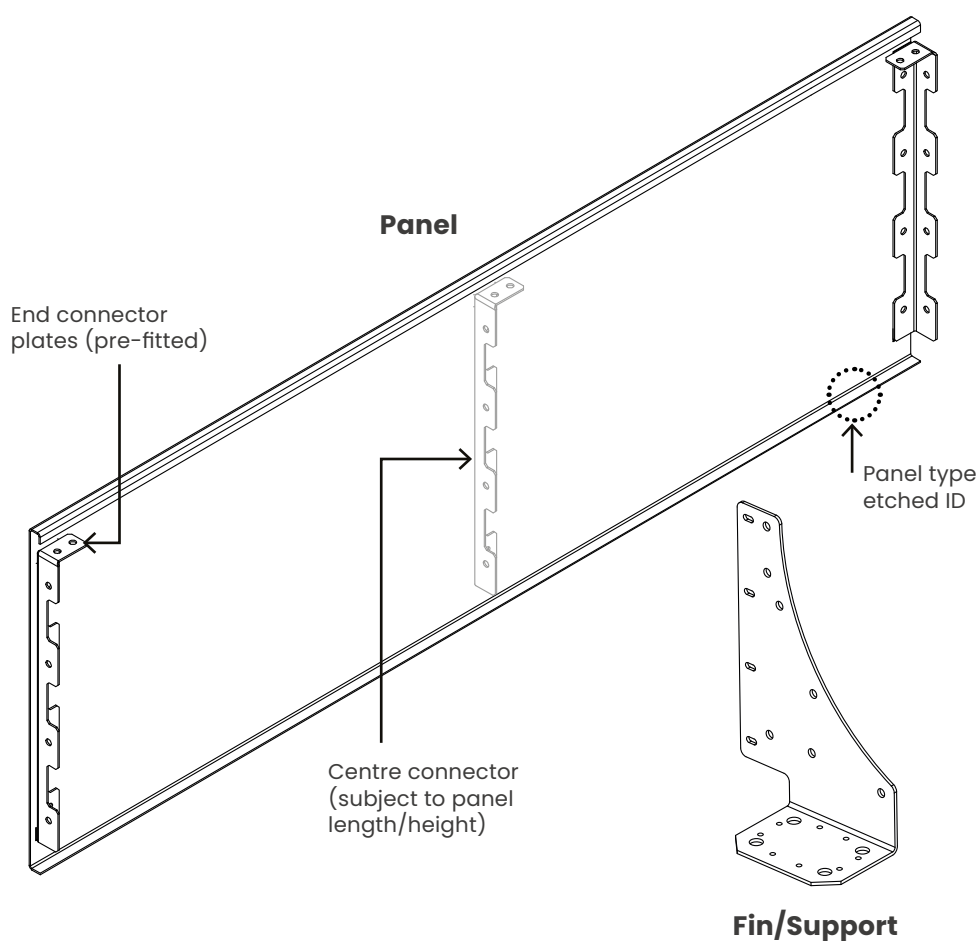

Top bracket

For jointing adjacent wall panels

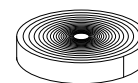

Sealant tape

Self-adhesive neoprene strip supplied for onsite cutting & fixing to wall panel end connector plates



Fixings

M8 x 30 Hex head screw, nut & washers, common to all steelwork joints



Furnitubes reserve the right to alter designs and dimensions at any time to improve our products. Please ensure that you have the latest issue of the document. Dimensions are given for information purposes only, all measurements are in mm and weights in KG unless otherwise stated. If dimensions are critical please contact our sales team. Document issue 1, date 29/07/2024.

AKRI Snap.

Seating. Parts supplied

AKRI Snap seating is supplied in 2 parts, the bench unit and the supports with associated fixings either prefitted or loose. Platforms are supplied with bolted fixing brackets.

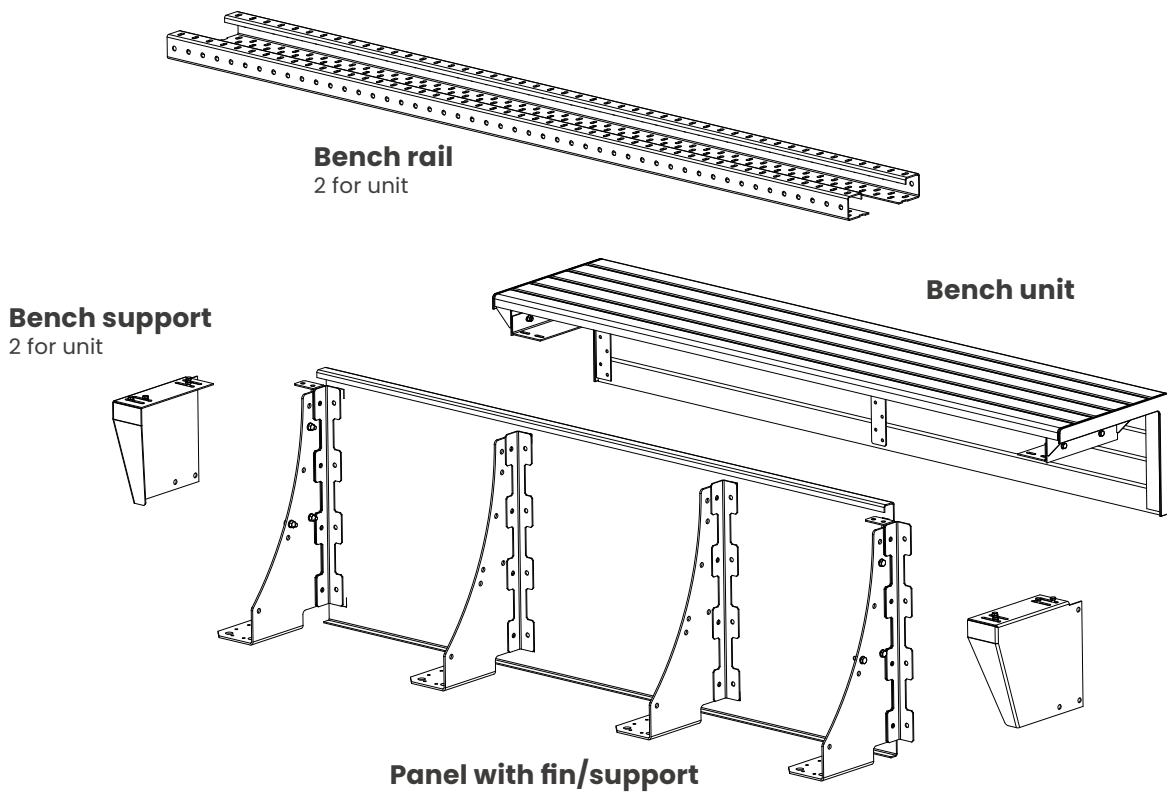

Installation of seating is best done before the planter's walling is full of soil. If planter wall is filled with soil we recommend localised excavation of soil/planting around the wall where the seating is to be placed. Typically, the length of the bench plus 300mm offset should provide sufficient working area to install the seating.



Furnitubes reserve the right to alter designs and dimensions at any time to improve our products. Please ensure that you have the latest issue of the document. Dimensions are given for information purposes only, all measurements are in mm and weights in KG unless otherwise stated. If dimensions are critical please contact our sales team. Document issue 1, date 29/07/2024.

AKRI Snap.

Installation instructions

Ground fixed

Ground fixing is most suited to the street scene, where bolting to the ground isn't an issue. Ground fixing includes the concrete base, the substrate, and the paving, deck, or tiles. The height in blue will be the finished height. The height in green will be the overall height of the planter. This height will depend on the ground and the type of planting design.

For permanent installation in public areas, we recommend that the products are fixed down to the ground. Standard fixing holes sizes for support are 4 no. Ø20mm (for M10 to M16 anchors), we recommend using M12 bolts and ground anchor fixings, which are not supplied.

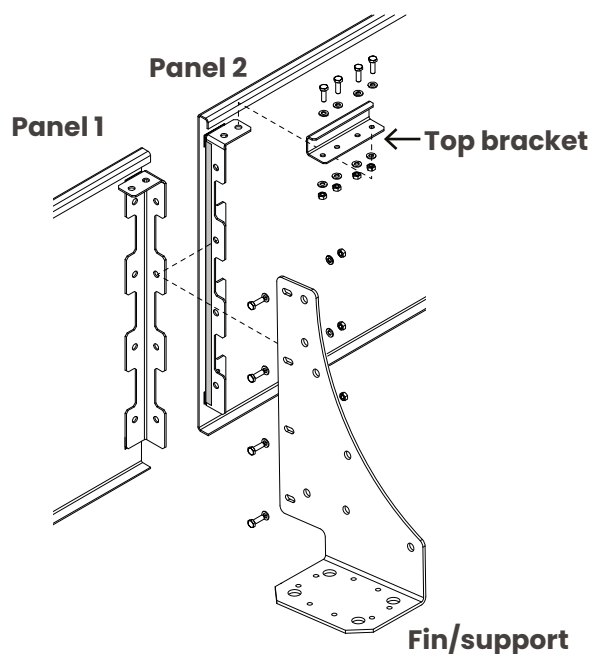
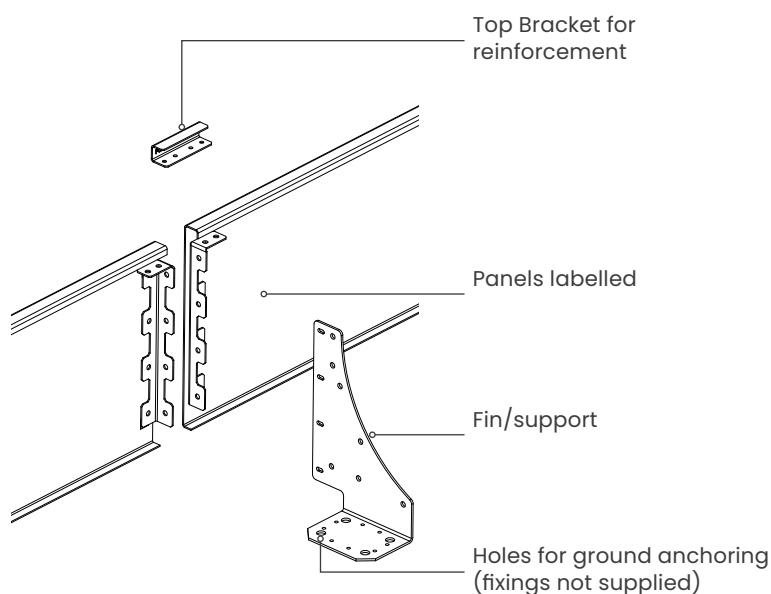
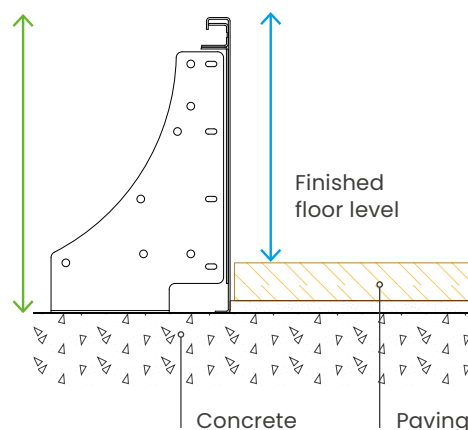

Furnitubes reserve the right to alter designs and dimensions at any time to improve our products. Please ensure that you have the latest issue of the document. Dimensions are given for information purposes only, all measurements are in mm and weights in KG unless otherwise stated. If dimensions are critical please contact our sales team. Document issue 1, date 29/07/2024.

AKRI Snap.

Installation instructions

Pedestal & tray

The pedestal & tray system is most suited to sites with restricted ground fixing. Our unique system allows the planter to be 'free-standing', bolting to itself. The height in blue will be the finished height. The height in green will be the overall height of the planter. This height will depend on the ground level and the type of planting design.

Supports and structure should be fixed together using the supplied self-drilling screw through both the plate and pedestal top, avoiding both the edge and centre.

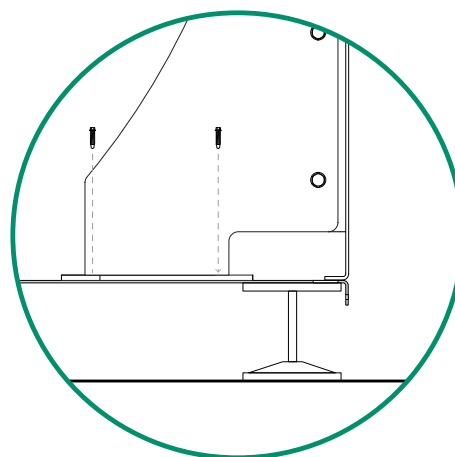
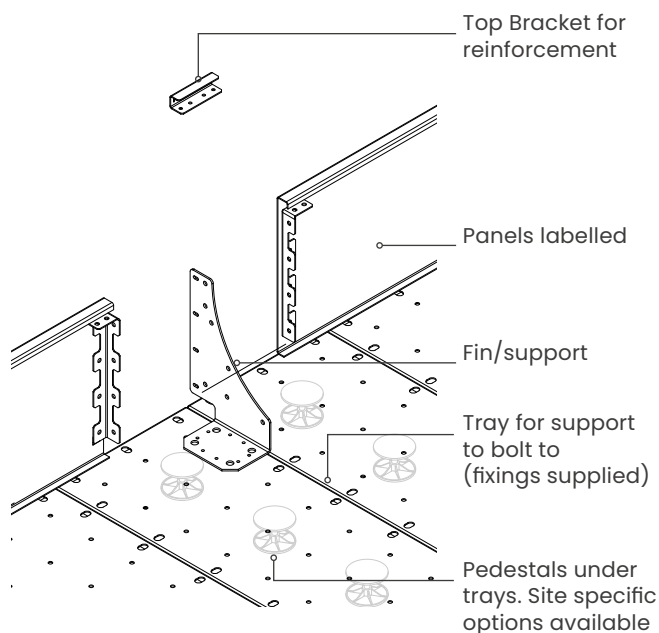
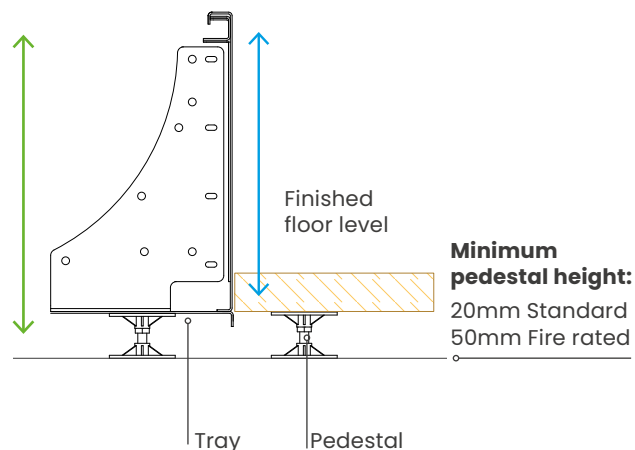

Furnitubes reserve the right to alter designs and dimensions at any time to improve our products. Please ensure that you have the latest issue of the document. Dimensions are given for information purposes only, all measurements are in mm and weights in KG unless otherwise stated. If dimensions are critical please contact our sales team. Document issue 1, date 29/07/2024.

AKRI Snap.

General assembly & care instructions

Consider site specific issues and constraints when choosing where to start.

Before fixing any joints, the sealant strip should be applied to one common end (e.g. all left hand ends) of the connector on all panels.

Loosely fix all supports and panels when planter wall is in position to ensure correct placement before fully tightening. We recommend using half of the fixings initially and then work around again when the position is confirmed. First, offer up panels to each other, then place support to one side of the end connector. Note: until the complete wall is connected to form a loop, the assembly may be unstable, use props to support it.

To fix the top bracket, offer up and pivot the bracket into the hollow of the return at the top of the panel. Loosely secure the panel with nuts, bolts, and washers to the top face of the end-connector plates in both places on each panel. When the wall/planter size and alignment are correct, a single wall support post should be permanently fixed down to the foundation, ensuring that it is set true plumb in all directions. Do this before fully tightening all other fixings between planters.

All fixings should be tightened to 28Nm torque. Holes in the base plates of the support can be used to mark and drill through the ground fixings in the wall foundation. We recommend using a ground fixing that does not require a hole size larger than $\varnothing 20\text{mm}$, so that holes can be drilled in the concrete with the wall support posts in place.



Furnitubes reserve the right to alter designs and dimensions at any time to improve our products. Please ensure that you have the latest issue of the document. Dimensions are given for information purposes only, all measurements are in mm and weights in KG unless otherwise stated. If dimensions are critical please contact our sales team. Document issue 1, date 29/07/2024.

Filling planter and installing an irrigation system

The planter can be infilled with the planting medium when all ground fixings are set and tightened. Do not fill the planter to higher than 50mm below the top edge of the wall. If installing an irrigation system within the planter, ensure that water is not directly sprayed onto the steel.

Personnel and tools required

- Sufficient site personnel are required to safely and efficiently undertake installation and assembly. Fixing holes are pre-drilled in all AKRI Snap system panels, supports, and top brackets.
- As a guideline, we would recommend a minimum of 4 suitably skilled workers.
- General building tools will be required for the formation of the concrete foundation.
- Timber props, packers, and other temporary devices are useful to adequately secure the panels when it is loosely assembled.
- Spanners/sockets for M8 hex head bolts and nuts are required.
- Approx. weight of panels -58Kg (based off panel 800mm high x 2000mm long)
- Care should be taken when manually handling these items.

General handling - health and safety

Good lifting and transporting practices should be adopted to protect the installer and members of the public prior to their installation. Hand and foot protection must be used when carrying out these practices.