

Zenith & Horizon Seating and tables.





Zenith & Horizon.

Contemporary styling combined
with robust manufacture

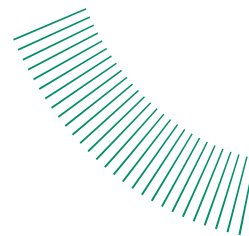
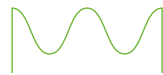

Since Furnitubes designed and launched its first Zenith over a decade ago, the range has proved to be one of our most popular seating products. From the original seat design has grown a comprehensive range of straight and curved seats and benches, available in a wide selection of forms, sizes and material options. The original Zenith seats have a characteristic aerofoil shape end profile.

A new variation is now offered in the form of the Zenith Horizon range, with

flat seat and backrest profiles giving a more contemporary appearance to the original design. Complementary tables are available in both ranges.

Whatever your choice of specific product, the Zenith range will deliver quality design and manufacturing detail to your scheme. As well as seating-based items, the Zenith range also comprises a number of bollard and litter bin options that allow a coordinated suite of products to be used across an entire scheme.

Zenith Horizon Range

The simplified end profile of the Horizon makes for flat seat and backrests and a contemporary character. Unique features and benefits of this range include:

- Coordinated widths of seats and benches allows adjacent placement of different forms to create continuous seating runs
- Curved seats and benches can be used to create geometric layouts such as circles and waves, and if different radii sizes are mixed, can form more organic layouts
- Straight seats can have side-to-side or front-to-back timbers, each with its own distinct aesthetic and complementary styling of armrests
- Separate platform and post sub-assemblies, allowing seat platforms to be removed for any routine maintenance works or simple replacement

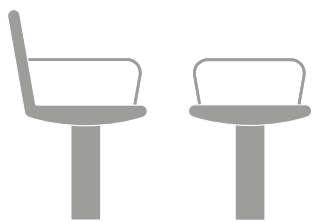

Zenith (Original) Range

The original Zenith design is characterised by aerofoil-shaped ends to the seat platform and curved profile seat and backrest. Timbers run side-to-side on straight seats and front-to-back on curved versions. Unique features and benefits of this range include:

- Long-established popular range of seating options that have been proven to withstand the rigours of placement in the public realm throughout the UK for many years
- Wide range of seat slat material options, particularly on straight versions, including timber, wood plastic composite, recycled plastic, steel and stainless steel
- Separate platform and post sub-assemblies, allowing seat platforms to be removed for any routine maintenance works or simple replacement

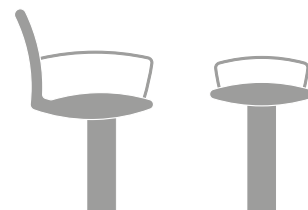

Zenith Range.

Zenith Straight Seats & Benches.

The original Zenith range is supplied as separate platform and post sub-assemblies steel framework with seat and backrests infilled in a choice of materials and finishes.

Steelwork is hot dip galvanised as standard (with the option of a supplementary polyester powder coated or plastic coated finish) or alternatively can be supplied in stainless steel, in various grades and finishes.

Zenith straight seats and benches are offered in many different configurations as standard, and other special variations can be readily supplied on request. Complementary curved seats and benches are also available for the timber slatted version.

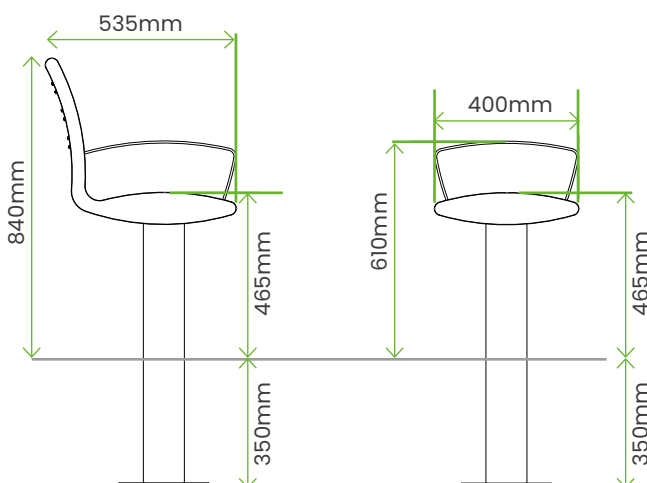

ZENITH SEATING: SUMMARY OF SEAT SLAT SIZE, MATERIAL & FINISH OPTIONS

	BENCHES:			SEATS:		
	1.83m Straight	2.43m Straight	Curved (all radii)	1.83m Straight	2.43m Straight	Curved (all radii)
Iroko hardwood, 65 x 32mm Smooth planed finish	•	•	•	•	•	•
	(4 slats)			(4 + 3 slats)		
Wood plastic composite (WPC), 65 x 32mm Dark iroko colour	•	•	-	•	•	-
	(4 slats)			(4 + 3 slats)		
Recycled plastic, 104 x 34mm Brown or black colours	•	•	-	•	•	-
	(3 slats)			(3 + 2 slats)		
Mild steel galvanised, 65 x 32mm PPC coated to any RAL reference Plastic coated in selected colours	•	•	-	•	•	-
	(4 slats)			(4 + 3 slats)		
Stainless steel G304 / G316. 65 x 32mm Satin or mirror polished	•	•	-	•	•	-
	(4 slats)			(4 + 3 slats)		

Zenith Straight Seating Armrests.

Armrests to suit your requirement

Armrests define individual seating spaces and are particularly useful to less able-bodied people as an aid to lowering themselves onto and alighting off a seat. Appropriate placement of armrests can also deter rough sleeping. The positions of armrests on all Zenith range seating are pre-determined to provide a comfortable seating width, and a number of different configurations are possible on standard

3- and 4-person seats and benches, as illustrated below, with each combination given a unique code suffix.

Other armrest combinations are possible, though we would recommend that they are always fixed at the standard positions in order to maintain comfortable seating position widths, and not to divide the seat into sizes that result in 'dead space'.

3-person seats



Arms: none
Suffix: none



Arms: 2 Ends
Suffix: **A**



Arms: 2 Centres
Suffix: **C**



Arms: 2 Ends + 2 Centres
Suffix: **AC**

4-person seats

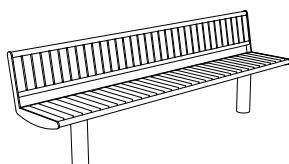

Arms: none
Suffix: none

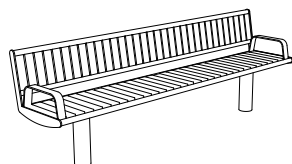

Arms: 2 Ends
Suffix: **A**

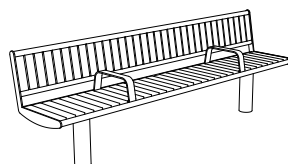

Arms: 2 Centres
Suffix: **C**

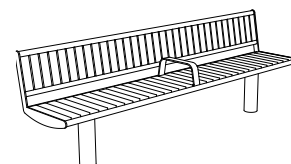

Arms: 1 Mid
Suffix: **M**

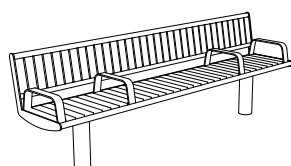

Arms: 2 Ends + 2 Centres
Suffix: **AC**

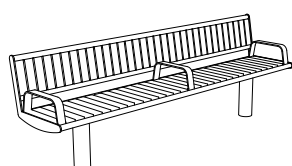

Arms: 2 Ends + 1 Mid
Suffix: **AM**

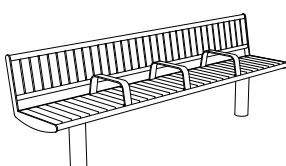

Arms: 2 Centres + 1 Mid
Suffix: **CM**

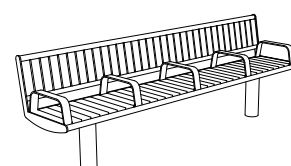

Arms: 2 Ends + 2 Centres + 1 Mid
Suffix: **ACM**

ZENITH.

Straight seats & benches

Standard assembly: steel frame and posts for in-ground fixing, hot dip galvanised, with iroko timber slats in smooth planed finish

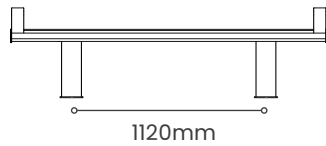

1120mm
3 person / 1830mm long seats & benches have 2 support posts

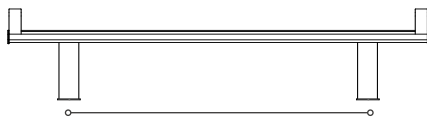

1720mm
4 person / 2430mm long seats & benches have 2 support posts

Seat

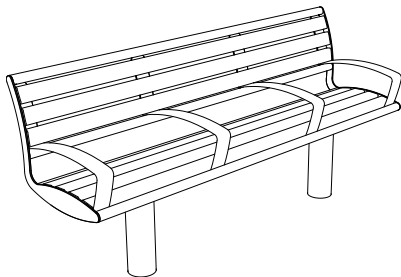

3 person / 1830mm long

SEAT WITHOUT ARMS	ZEN 6
SEAT + 2 END ARMS	ZEN 6A
SEAT + 2 CENTRE ARMS	ZEN 6C
SEAT + 2 END & 2 CENTRE ARM	ZEN 6AC

4 person / 2430mm long

SEAT WITHOUT ARMS	ZEN 8
SEAT + 2 END ARMS	ZEN 8A
SEAT + 2 CENTRE ARMS	ZEN 8C
SEAT + 1 MID ARM	ZEN 8M
SEAT + 2 END & 2 CENTRE ARMS	ZEN 8AC
SEAT + 2 END & 1 MID ARMS	ZEN 8AM
SEAT + 2 CENTRE & 1 MID ARM	ZEN 8CM
SEAT + 2 END, 2 CENTRE & 1 MID ARMS	ZEN 8ACM

Options (All Seats & Benches)

- Other overall lengths, including 1 or 2 person seats / benches
- Alternative armrest configurations
- Base plated posts for bolt-down installation
- Anti-skate devices on front bar (+ rear bar for benches)
- Framework & posts in polyester powder coated finish
- Framework & posts in plastic coated finish
- Framework & posts in stainless steel, various grades & finishes
- Alternative slat materials, including wood plastic composite (WPC) (3-person only)

Bench

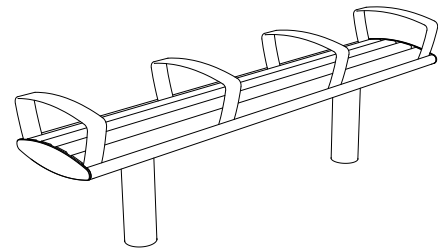

3 person / 1830mm long

SEAT WITHOUT ARMS	ZEN B6
SEAT + 2 END ARMS	ZEN B6A
SEAT + 2 CENTRE ARMS	ZEN B6C
SEAT + 2 END & 2 CENTRE ARM	ZEN B6AC

4 person / 2430mm long

SEAT WITHOUT ARMS	ZEN B8
SEAT + 2 END ARMS	ZEN B8A
SEAT + 2 CENTRE ARMS	ZEN B8C
SEAT + 1 MID ARM	ZEN B8M
SEAT + 2 END & 2 CENTRE ARMS	ZEN B8AC
SEAT + 2 END & 1 MID ARMS	ZEN B8AM
SEAT + 2 CENTRE & 1 MID ARM	ZEN B8CM
SEAT + 2 END, 2 CENTRE & 1 MID ARMS	ZEN B8ACM

Zenith Curved Seating ●

Curved seating is a popular choice for many locations, serving to visually break up orthogonal site layouts and emphasise features such as trees. Curved seating can be used independently, in pairs or multiples to create arcs (benches can also be used in wave arrangements) or linked to form complete circles.

Whilst benches can be accessed from either side, seats are supplied with either internal or external backrests. Slats on curved seating are arranged in a radial / front-to-back layout

(contrasting with the side-to-side arrangement on straight seats) and are profiled to match the aerofoil shape of the steelwork end frames. Four curve sizes – from 1.8m up to to 3.6m – are offered as standard, all configured around a given number of units to form a complete circle, with each segment designed for 3 people. Removal of segments whilst maintaining the same setting out arrangement allows access to the centre of the circle. Other sizes to suit site-specific dimensions can be supplied on request.

Bench

Benches are a popular choice where access can be gained from both sides, allowing people to sit facing opposite directions. Benches are most often used for 'short stay' seating locations.

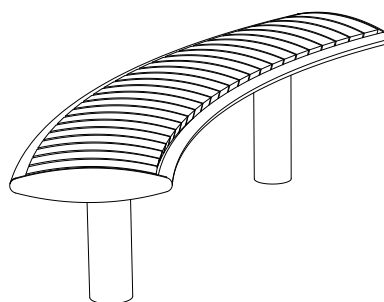

Seat – internal backrest

Most often used around features such as specimen trees, convex seats are ideal for outward-looking situations. The geometry of the design means that back slats are more tightly spaced than seat slats.

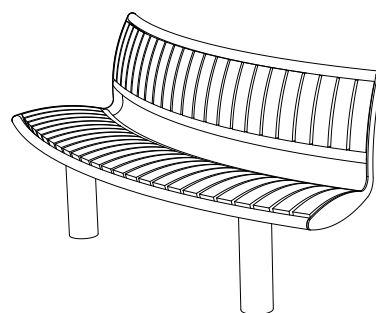

Seat – external backrest

These seats are often used to round off corners or to focus on a central feature in the landscape. The geometry of the design means that back slats are less tightly spaced than seat slats.

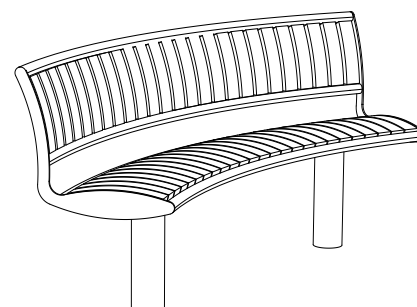

Zenith Curved Seats & Benches.

60° / 1.8m radius, 3 person seat & bench units

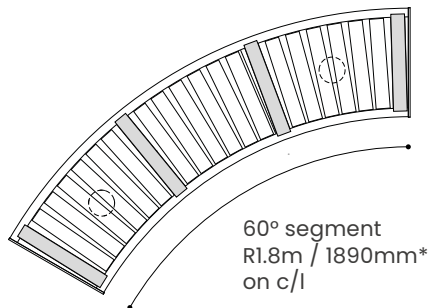

60° segment
R1.8m / 1890mm*
on c/l

BENCHES

ZEN RB 186

SEATS WITH INTERNAL BACKREST

ZEN RSX 186

SEATS WITH EXTERNAL BACKREST

ZEN RSV 186

45° / 2.4m radius, 3 person seat & bench units

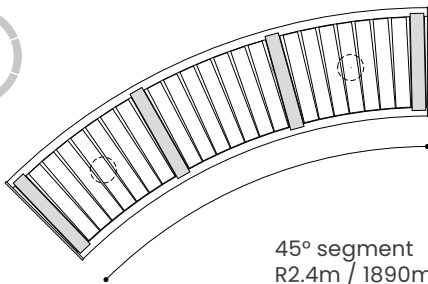

45° segment
R2.4m / 1890mm*
on c/l

BENCHES

ZEN RB 248

SEATS WITH INTERNAL BACKREST

ZEN RSX 248

SEATS WITH EXTERNAL BACKREST

ZEN RSV 248

36° / 3.0m radius, 3 person seat & bench units

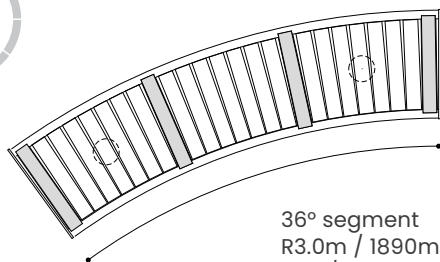

36° segment
R3.0m / 1890mm*
on c/l

BENCHES

ZEN RB 3010

SEATS WITH INTERNAL BACKREST

ZEN RSX 3010

SEATS WITH EXTERNAL BACKREST

ZEN RSV 3010

30° / 3.6m radius, 3 person seat & bench units

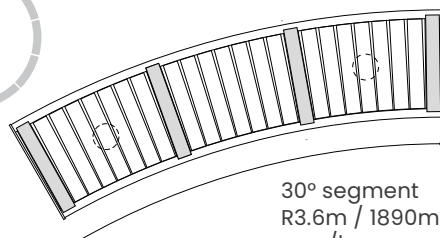

30° segment
R3.6m / 1890mm*
on c/l

BENCHES

ZEN RB 3612

SEATS WITH INTERNAL BACKREST

ZEN RSX 3612

SEATS WITH EXTERNAL BACKREST

ZEN RSV 3612

Zenith Picnic Benches & Tables.

Timber-topped table with central steel plate

Available in two standard lengths, to suit either 6 or 8 sitters, the original Zenith table is designed to complement the corresponding seating range.

Tough materials and robust construction makes the tables a popular choice for a wide range of sites, from outdoor dining areas in schools and education campuses, to seafronts and woodland picnic areas. Other lengths are available on request, including shorter versions which can serve as fixed games tables in a public realm situation. The inset posts on all versions make the table accessible to wheelchair users from both ends.

Although generally supplied as an independent item, the table can be joined (either above or below ground) to benches or seats via low level plates to form a single-piece picnic-style table set, which can be bolted down or used as a freestanding unit.



Options (All Seats & Benches)

- Other overall lengths, including 2 or 4 person tables
- Base plated posts for bolt-down installation
- Combined assembly with benches or seats for freestanding or bolt-down installation
- Framework & posts in polyester powder coated finish
- Framework & posts in plastic coated finish
- Framework & posts in stainless steel, various grades & finishes
- Alternative slat materials, including wood plastic composite (WPC)
- Timbers with UV protective finish

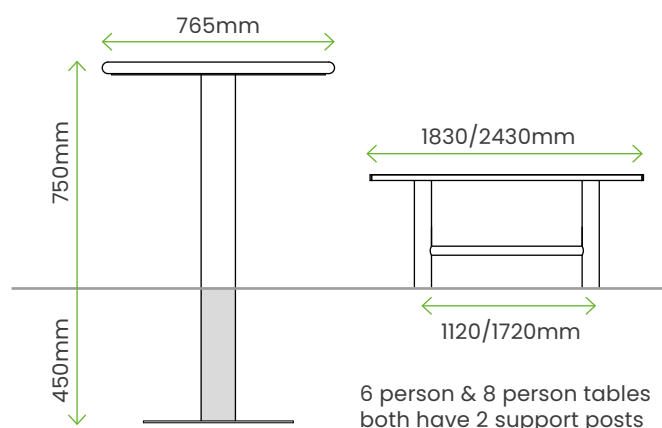

**6 PERSON (3 PER SIDE) /
1830MM LONG TABLE**

ZEN T6

**8 PERSON (4 PER SIDE) /
2430MM LONG TABLE**

ZEN T8

Zenith Horizon Range.

Second generation Zenith Seating.

The Horizon range offers many of the features of the original Zenith design, but has been re-styled to suit more contemporary settings and with the following key differences:

- Common width to platforms of both seat and bench, so they can be used side-by-side to create a continuous lines of multi-form seating.
- Two slat orientations. Side-to-side slats are available on straight line seating only, and front-to-back slats are standard options on both straight and curved seating for a fully coordinated appearance on sites that use multiple variations of seat forms.

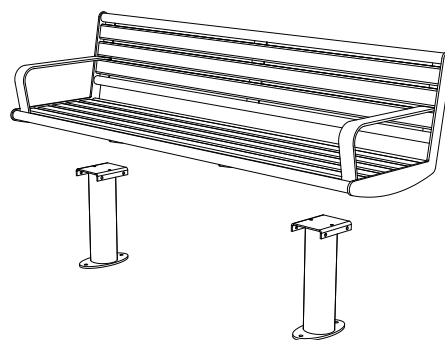

Continuous seating

A major benefit of the new Zenith Horizon range is that the platform profiles and the alignment of the support posts are common to both the seat and bench, meaning they can be placed side-by-side to form a continuous line of variable form seating. This takes up less space than separated independent seats, provides different types of seating to suit the needs of different user groups, and also looks more interesting than identical seating throughout.

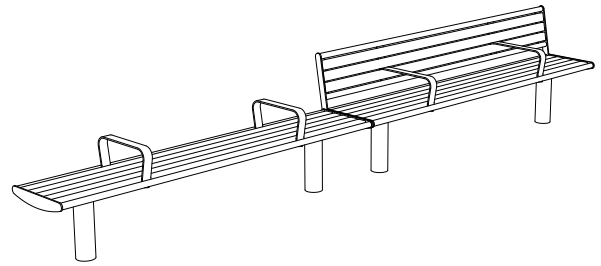

Side-to-side slats

A major benefit of the new Zenith Horizon range is that the platform profiles and the alignment of the support posts are common to both the seat and bench, meaning they can be placed side-by-side to form a continuous line of variable form

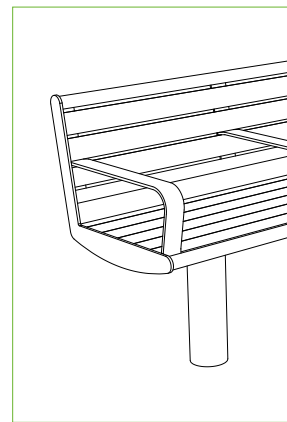

Front-to-back slats

This range uses shorter but a greater number of slats, which gives a slightly more refined aesthetic compared with equivalent seating with side-to-side slats. The principle benefit though is that slats can be arranged radially on curved seating, to allow circular and wave-form layouts. Armrests, which are common to seat and bench units, taper inwards at the top.

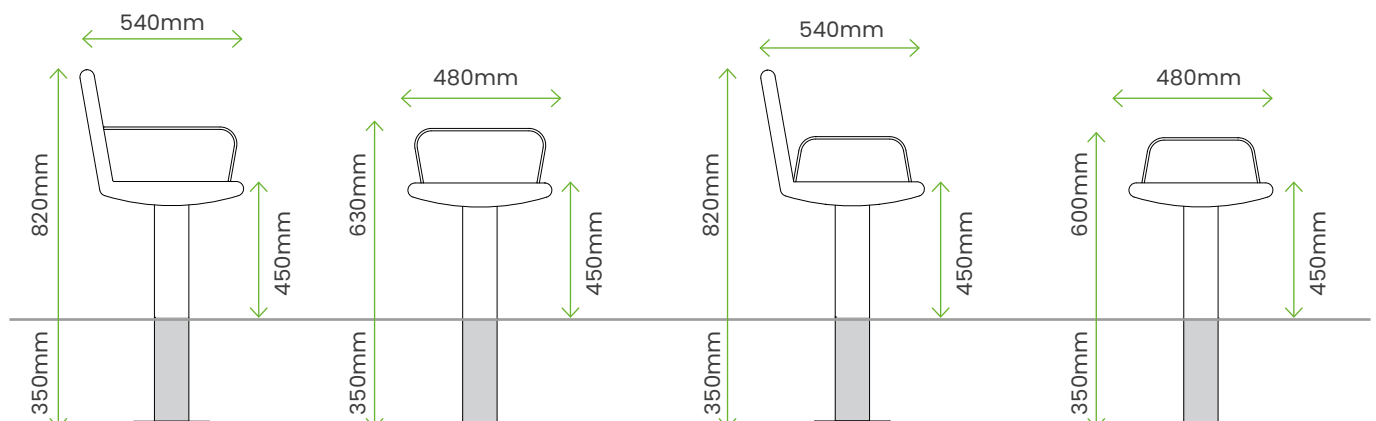

ZENITH Horizon.

Side-to-side slats Straight seats & benches

Standard assembly: steel frame & bolt-on posts for in-ground fixing, hot dip galvanised, with iroko timber slats in smooth planed finish

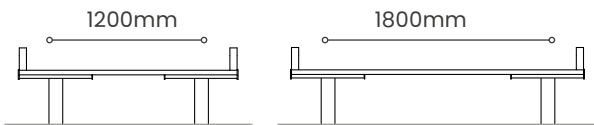

3 person / 1890mm long & 4 person / 2490mm long seats & benches all have 2 support posts

Options (All Seats & Benches)

- Other overall lengths, including 1 or 2 person seats / benches
- Alternative armrest configurations
- Base plated posts for bolt-down installation
- Anti-skate devices on front bar (+ rear bar for benches)
- Framework & posts in polyester powder coated finish
- Framework & posts in plastic coated finish
- Framework & posts in stainless steel, various grades & finishes
- Timbers with UV protective finish

Seat

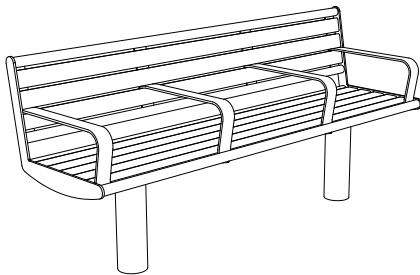

3 person / 1890mm long

SEAT WITHOUT ARMS	ZNH 6
SEAT + 2 END ARMS	ZNH 6A
SEAT + 2 CENTRE ARMS	ZNH 6C
SEAT + 2 END & 2 CENTRE ARM	ZNH 6AC

4 person / 2490mm long

SEAT WITHOUT ARMS	ZNH 8
SEAT + 2 END ARMS	ZNH 8A
SEAT + 2 CENTRE ARMS	ZNH 8C
SEAT + 1 MID ARM	ZNH 8M
SEAT + 2 END & 2 CENTRE ARMS	ZNH 8AC
SEAT + 2 END & 1 MID ARMS	ZNH 8AM
SEAT + 2 CENTRE & 1 MID ARM	ZNH 8CM
SEAT + 2 END, 2 CENTRE & 1 MID ARMS	ZNH 8ACM

Bench

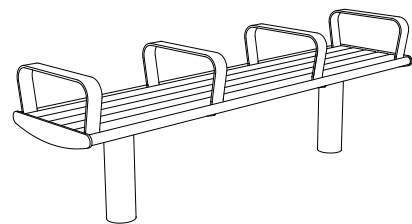

3 person / 1890mm long

SEAT WITHOUT ARMS	ZNH B6
SEAT + 2 END ARMS	ZNH B6A
SEAT + 2 CENTRE ARMS	ZNH B6C
SEAT + 2 END & 2 CENTRE ARM	ZNH B6AC

4 person / 2490mm long

SEAT WITHOUT ARMS	ZNH B8
SEAT + 2 END ARMS	ZNH B8A
SEAT + 2 CENTRE ARMS	ZNH B8C
SEAT + 1 MID ARM	ZNH B8M
SEAT + 2 END & 2 CENTRE ARMS	ZNH B8AC
SEAT + 2 END & 1 MID ARMS	ZNH B8AM
SEAT + 2 CENTRE & 1 MID ARM	ZNH B8CM
SEAT + 2 END, 2 CENTRE & 1 MID ARMS	ZNH B8ACM

ZENITH Horizon.

Front-to-back slats Straight seats & benches

Standard assembly: steel frame & bolt-on posts for in-ground fixing, hot dip galvanised, with iroko timber slats in smooth planed finish

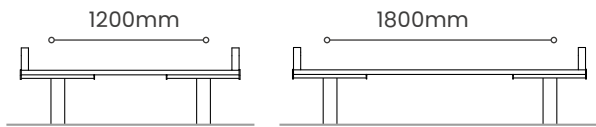

3 person / 1890mm long & 4 person / 2470mm long seats & benches all have 2 support posts

Options (All Seats & Benches)

- Other overall lengths, including 1 or 2 person seats / benches
- Alternative armrest configurations
- Base plated posts for bolt-down installation
- Anti-skate devices on front bar (+ rear bar for benches)
- Framework & posts in polyester powder coated finish
- Framework & posts in plastic coated finish
- Framework & posts in stainless steel, various grades & finishes
- Timbers with UV protective finish
- Wood plastic composite (WPC) slats

Seat

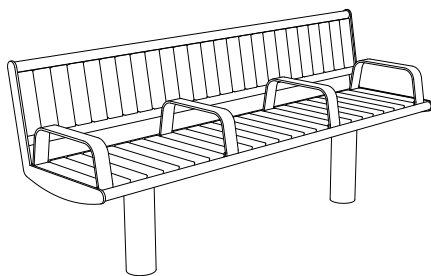

3 person / 1890mm long

SEAT WITHOUT ARMS	ZNF 6
SEAT + 2 END ARMS	ZNF 6A
SEAT + 2 CENTRE ARMS	ZNF 6C
SEAT + 2 END & 2 CENTRE ARM	ZNF 6AC

4 person / 2490mm long

SEAT WITHOUT ARMS	ZNF 8
SEAT + 2 END ARMS	ZNF 8A
SEAT + 2 CENTRE ARMS	ZNF 8C
SEAT + 1 MID ARM	ZNF 8M
SEAT + 2 END & 2 CENTRE ARMS	ZNF 8AC
SEAT + 2 END & 1 MID ARMS	ZNF 8AM
SEAT + 2 CENTRE & 1 MID ARM	ZNF 8CM
SEAT + 2 END, 2 CENTRE & 1 MID ARMS	ZNF 8ACM

Bench

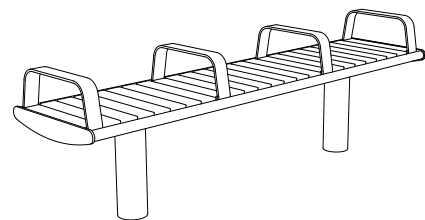

3 person / 1890mm long

SEAT WITHOUT ARMS	ZNF B6
SEAT + 2 END ARMS	ZNF B6A
SEAT + 2 CENTRE ARMS	ZNF B6C
SEAT + 2 END & 2 CENTRE ARM	ZNF B6AC

4 person / 2490mm long

SEAT WITHOUT ARMS	ZNF B8
SEAT + 2 END ARMS	ZNF B8A
SEAT + 2 CENTRE ARMS	ZNF B8C
SEAT + 1 MID ARM	ZNF B8M
SEAT + 2 END & 2 CENTRE ARMS	ZNF B8AC
SEAT + 2 END & 1 MID ARMS	ZNF B8AM
SEAT + 2 CENTRE & 1 MID ARM	ZNF B8CM
SEAT + 2 END, 2 CENTRE & 1 MID ARMS	ZNF B8ACM

Zenith Horizon Curved Seating •

Standard curved options to suit most sites

Armrests define individual seating spaces and are particularly useful to less able-bodied people as an aid to lowering themselves onto and alighting off a seat. Appropriate placement of armrests can also deter rough sleeping. The positions of armrests on all Zenith range seating are pre-determined to provide a comfortable seating width, and a number of different configurations are possible on standard

3- and 4-person seats and benches, as illustrated below, with each combination given a unique code suffix.

Other armrest combinations are possible, though we would recommend that they are always fixed at the standard positions in order to maintain comfortable seating position widths, and not to divide the seat into sizes that result in 'dead space'.

Bench

Benches are a popular choice where access can be gained from both sides, allowing people to sit facing opposite directions. Benches are most often used for 'short stay' seating locations.

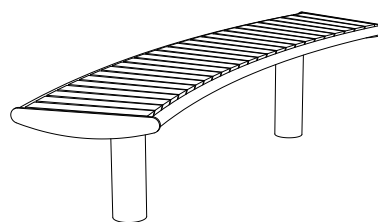

Seat - internal backrest

Most often used around features such as specimen trees, and ideal for outward-looking situations. The backrest provides a comfortable support for longer term seating.

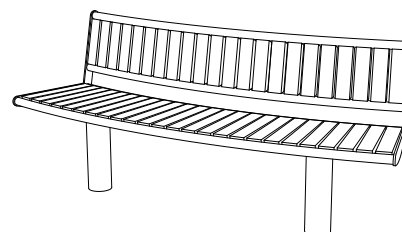

Seat - external backrest

These seats are often used to focus on a central feature in the landscape or to provide visually softer alternative to corner seating.



Zenith Horizon Curved Seating.

60° / 1.8m radius, 3 person seat & bench units

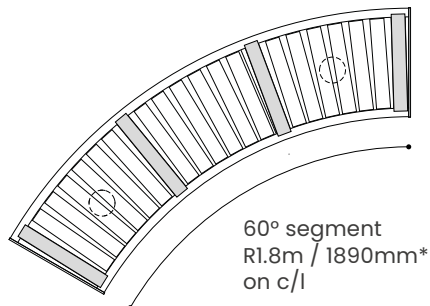

BENCHES

ZNF RB 186

SEATS WITH INTERNAL BACKREST

ZNF RSX 186

SEATS WITH EXTERNAL BACKREST

ZNF RSV 186

45° / 2.4m radius, 3 person seat & bench units

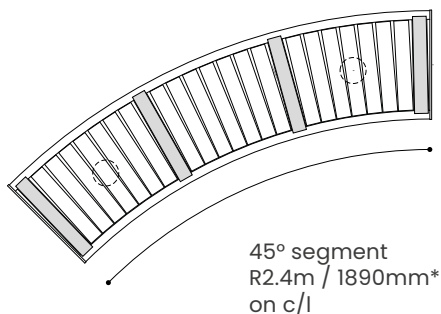

BENCHES

ZNF RB 248

SEATS WITH INTERNAL BACKREST

ZNF RSX 248

SEATS WITH EXTERNAL BACKREST

ZNF RSV 248

36° / 3.0m radius, 3 person seat & bench units

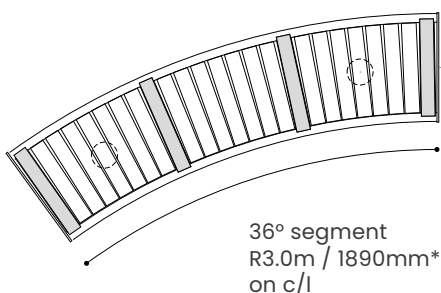

BENCHES

ZNF RB 3010

SEATS WITH INTERNAL BACKREST

ZNF RSX 3010

SEATS WITH EXTERNAL BACKREST

ZNF RSV 3010

30° / 3.6m radius, 3 person seat & bench units

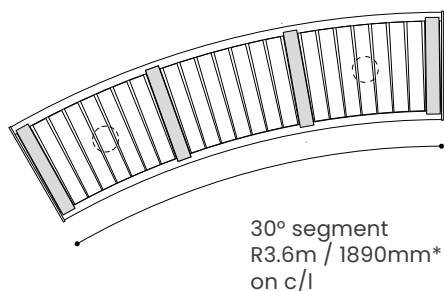

BENCHES

ZNF RB 3612

SEATS WITH INTERNAL BACKREST

ZNF RSX 3612

SEATS WITH EXTERNAL BACKREST

ZNF RSV 3612

Zenith Horizon Circular Seating •

Zenith Horizon in the round

Curved seating, and circular arrangements in particular, are a popular choice on many landscape schemes. Inward facing curves offer greater sociability compared with linear seating, and outward facing seating is often used to encircle a prominent site feature, such as a specimen tree.

Zenith Horizon curved seating units have been designed around four standard circle diameters - 3.6m, 4.8m, 6.0m and 7.2m (measured on the seating platform centre line) - which all divide up to give common unit lengths based on a 3-person seat.

There are multiple layout options, including fully enclosed circles, horseshoes with a single opening and circles with gaps for access into the central area. Internal or external backrests can be supplied on all individual units, with the further option of armrests if required.

Shown below and on the following page are examples of the types of circular layouts that can be achieved with standard Zenith Horizon curved seating units, shown on Ø3.6m layouts.

Enclosed circles

Full circular arrangements are ideal around site features such as trees, where users sit facing outwards and access to the central area is not needed.



6 x bench units



2 x bench units
4 x seats units with backrest

Horseshoes

Circular arrangements with a single gap allow access to the central space and are popular as exterior teaching areas in school grounds.



5 x bench units



2 x bench units
3 x seats units with backrest

Open circles

Gaps in circular arrangements allow access to the central area, including for wheelchairs, and also serve to visually break up large volumes of seating.







4 x bench units









2 x bench units
2 x seats units with backrest

Zenith Horizon Circular Seating.







Ø3.6M CIRCLE C/L (RADIUS 1.8M)

					
MODULE TYPE	6 X SEATING UNITS	5 X SEATING UNITS	4 X SEATING UNITS	4 X SEATING UNITS	3 X SEATING UNITS
SEATS	18 PEOPLE	15 PEOPLE	12 PEOPLE	12 PEOPLE	9 PEOPLE
GAP		1550MM	1550MM	800MM	1550MM







Ø4.8M CIRCLE C/L (RADIUS 2.4M)

						
MODULE TYPE	8 X SEATING UNITS	7 X SEATING UNITS	6 X SEATING UNITS	6 X SEATING UNITS	5 X SEATING UNITS	4 X SEATING UNITS
SEATS	24 PEOPLE	21 PEOPLE	18 PEOPLE	18 PEOPLE	15 PEOPLE	12 PEOPLE
GAP		1650MM	1650MM	1100MM	1000MM	1650MM

Ø6M CIRCLE C/L (RADIUS 3.0M)

						
MODULE TYPE	10 X SEATING UNITS	9 X SEATING UNITS	8 X SEATING UNITS	6 X SEATING UNITS	6 X SEATING UNITS	5 X SEATING UNITS
SEATS	30 PEOPLE	27 PEOPLE	24 PEOPLE	18 PEOPLE	18 PEOPLE	15 PEOPLE
GAP		1770MM	1700MM	2400MM	1150MM	1700MM

Ø7.2M CIRCLE C/L (RADIUS 3.6M)

							
MODULE TYPE	12 X SEATING UNITS	11 X SEATING UNITS	10 X SEATING UNITS	9 X SEATING UNITS	8 X SEATING UNITS	7 X SEATING UNITS	6 X SEATING UNITS
SEATS	36 PEOPLE	33 PEOPLE	30 PEOPLE	27 PEOPLE	24 PEOPLE	24 PEOPLE	18 PEOPLE
GAP		1750MM	1750MM	1750MM	1750MM	900MM	1750MM

Zenith Horizon Wave Seating •

Zenith Horizon with a twist

As with circular seating, wave-form / serpentine shapes are a popular choice for external seating provision, and are often employed in double aspect situations, where sitters can choose which way to view their surroundings.

From just 4 standard radius options, a wide variety of wave forms can be offered by the Zenith Horizon curved range, by introducing changes of direction to the individual units at different points, creating a visual range

Geometrical wave-forms

achieved by using:

- Common radius seating units
- Repeating pattern to changes in direction of individual units
- Armrest and backrests in repeating positions



Key plan

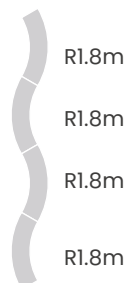

from gentle waves to accentuated peaks and troughs.

The examples shown immediately below left and opposite all use common-sized unit seats in a single arrangement, meaning the pattern has a distinct visual geometry. Different radius seating units can be adjoined to form more organic layouts, as shown in the example below right, with backrests and armrest on selected units only to further accentuate the informal appearance.

Organic wave-forms

achieved by using:

- A variety of different radius units
- Non-repetitive pattern to changes in curve direction
- Backrests and armrests in random positions

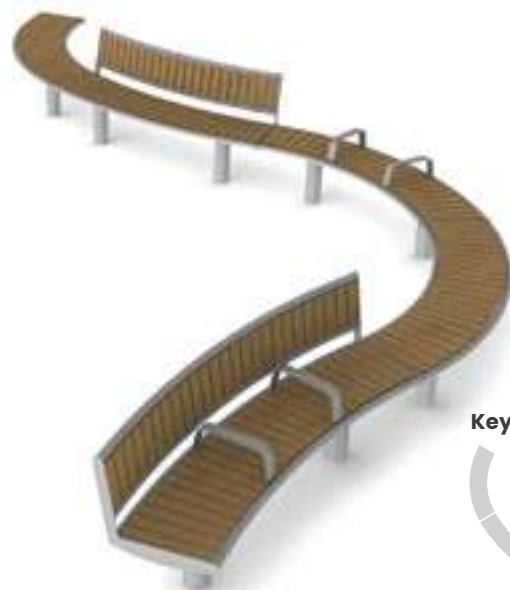

Key plan

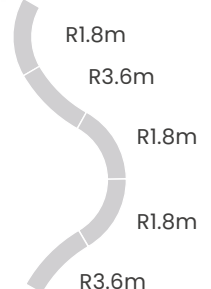

Wave configuration.

Alternate directions

Changing the direction of adjacent curved seating units results in a low profile wave layout, which provides a subtle variation to straight seating, without taking up too much space.

All layouts shown provide 6 seating places.

2 segment direction changes

Adjacent curved seats paired in the same direction accentuate the form of the wave, creating a more distinct S-shape layout, particularly on the tight radius models.

These compact layouts provide 12 seating places for good social seating provision.

3 segment direction changes

Groups of 3 curved seat units in the same direction give a more pronounced wave dynamic and make a strong visual statement on any site. Tighter radius modules give the impression of two adjoined and mirrored half circles, whereas the more relaxed radius curves create gentler elongated S-shapes.

C/L RADIUS 1.8M MODULES



MODULE TYPE 2 X 60° / 1890MM UNITS

SEATS 6 PEOPLE

OVERALL AREA 3850 X 980MM



MODULE TYPE 2 X 60° / 1890MM UNITS

SEATS 12 PEOPLE

OVERALL AREA 6670 X 2300MM



MODULE TYPE 6 X 60° / 1890MM UNITS

SEATS 18 PEOPLE

OVERALL AREA 7700 X 4100MM

C/L RADIUS 2.4M MODULES



MODULE TYPE 2 X 45° / 1890MM UNITS

SEATS 6 PEOPLE

OVERALL AREA 3870 X 870MM



MODULE TYPE 4 X 45° / 1890MM UNITS

SEATS 12 PEOPLE

OVERALL AREA 7140 X 1910MM



MODULE TYPE 6 X 45° / 1890MM UNITS

SEATS 18 PEOPLE

OVERALL AREA 9330 X 3460MM

C/L RADIUS 3.0M MODULES



MODULE TYPE 2 X 36° / 1890MM UNITS

SEATS 6 PEOPLE

OVERALL AREA 3870 X 790MM



MODULE TYPE 4 X 36° / 1890MM UNITS

SEATS 12 PEOPLE

OVERALL AREA 7350 X 1650MM



MODULE TYPE 6 X 36° / 1890MM UNITS

SEATS 18 PEOPLE

OVERALL AREA 10110 X 2970MM

C/L RADIUS 3.0M MODULES



MODULE TYPE 2 X 30° / 1890MM UNIT

SEATS 6 PEOPLE

OVERALL AREA 3870 X 750MM



MODULE TYPE 4 X 30° / 1890MM UNITS

SEATS 12 PEOPLE

OVERALL AREA 7450 X 1460MM



MODULE TYPE 6 X 30° / 1890MM UNITS

SEATS 18 PEOPLE

OVERALL AREA 10540 X 2610MM

Zenith Horizon Configuration.

Endless configuration possibilities

With the front-to-back slat versions of the Zenith Horizon range, standard straight and curved units can be set adjacent to each other to form seamless continuous run seating, for a practical solution with stunning visual interest, as in the example shown below.

Organic layouts such as this can be further enhanced by mixing benches and seats with backrests, with armrests employed on selected units only.

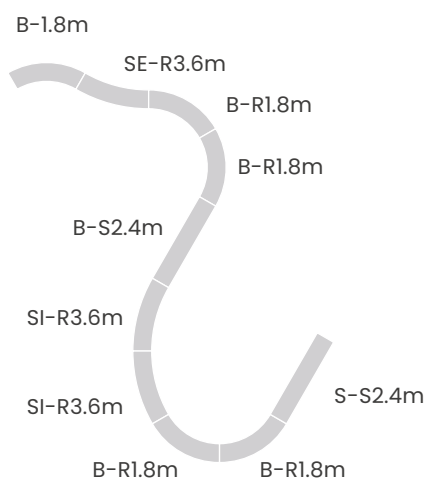

Key plan

Units on example configuration:

- B-S2.4m** Bench, straight, 2.4m long
- B-R1.8m** Bench, curved, 1.8m radius
- B-R3.6m** Bench, curved, 3.6m radius
- S-R3.6m** Seat, curved, external backrest, 3.6m radius
- SE-R3.6m** Seat, curved, internal backrest, 3.6m radius
- SI-S2.4m** Seat, straight, 2.4m long

Zenith Horizon Picnic Benches & Tables.

Steel-framed all timber-topped table

The table introduces the characteristic aerofoil end profile of the Zenith Horizon seating range, together with timbers arranged to match those used on the Horizon seating in a either side-to-side or front-to-back orientation, for a fully coordinated set of products.

Tables are available in two standard lengths, to suit either 6 or 8 sitters, which also matches standard seat lengths.

The central alignment of the table posts improves accessibility onto the seats for less able-bodied users and the inset from the ends means wheelchair users can be accommodated as standard.

Although generally supplied as an independent item, the table can be joined (either above or below ground) to benches or seats via a low level plate to form a single-piece picnic-style table set, which can be bolted down or used as a freestanding unit.



Options (All Seats & Benches)

- Other overall lengths, including 2 or 4 person tables
- Base plated posts for bolt-down installation
- Combined assembly with benches or seats for freestanding or bolt-down installation
- Framework & posts in polyester powder coated finish
- Framework & posts in plastic coated finish
- Framework & posts in stainless steel, various grades & finishes
- Wood plastic composite (WPC) slats – front-to-back slatted models only
- Timbers with UV protective finish

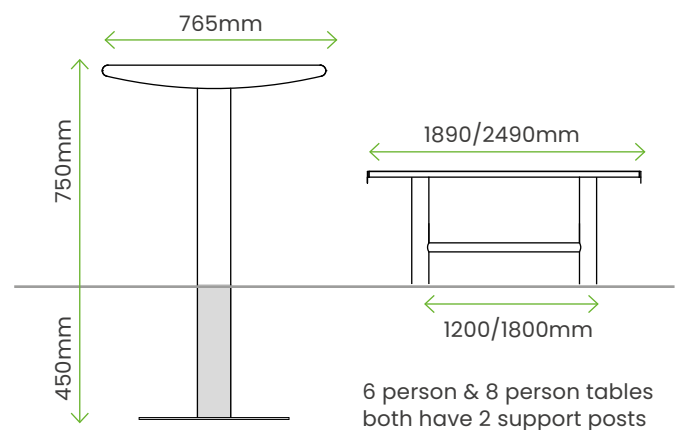

6 PERSON (3 PER SIDE) / 1890MM LONG TABLE, SIDE-TO-SIDE SLATS ZNH T6

8 PERSON (4 PER SIDE) / 2490MM LONG TABLE, SIDE-TO-SIDE SLATS ZNH T8

6 PERSON (3 PER SIDE) / 1890MM LONG TABLE, FRONT-TO-BACK SLATS ZNF T6

8 PERSON (4 PER SIDE) / 2490MM LONG TABLE, FRONT-TO-BACK SLATS ZNF T8

Installation.

In-ground



Advantages of an in-ground fixing are that it provides a permanent robust installation and the seat can be installed true plumb regardless of any slope to the paving. Removal of the seat involves disruptive ground excavation though.

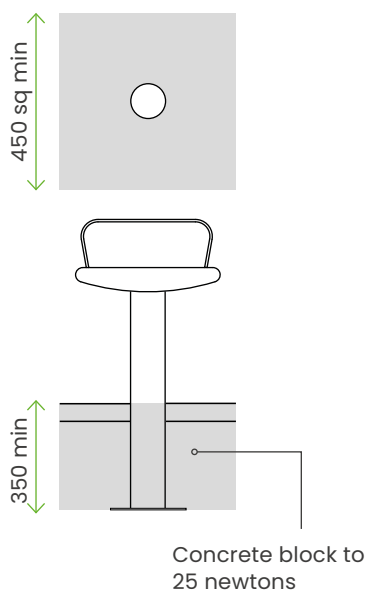

Bolt-down



Seat posts can be provided with base plates for a bolt-down installation onto concrete blocks. Bolting down allows for ease of removal, but seats are potentially vulnerable to theft and have to be installed parallel to the pavement, which may not be level.

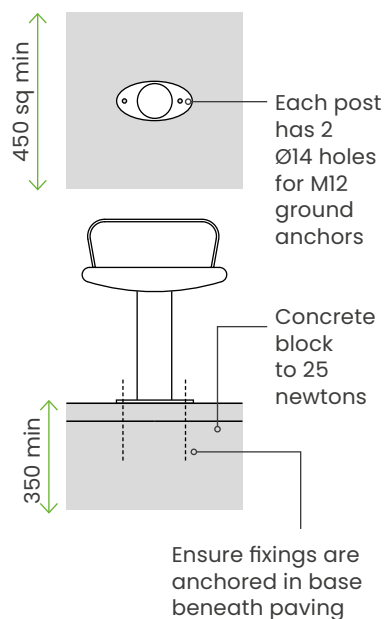

In-ground sockets



Seat posts can be provided with base plates for a bolt-down installation onto concrete blocks. Bolting down allows for ease of removal, but seats are potentially vulnerable to theft and have to be installed parallel to the pavement, which may not be level.

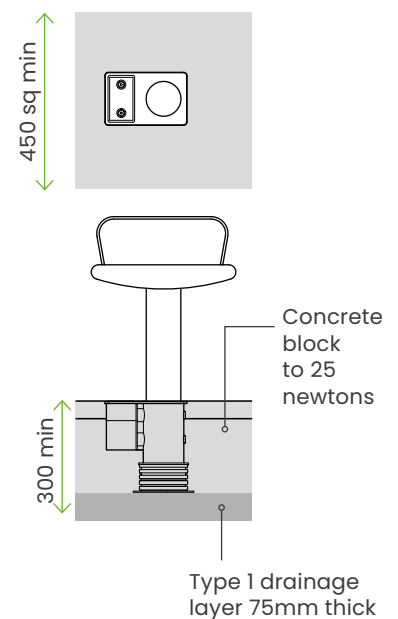

*** Note: sizes shown are minimum recommended foundation block for each seat post in normal ground conditions; if in doubt, seek the advice of a civil engineer.**

Case studies.

Some of our recent projects where you can see Zenith in its full glory



**Cheltenham
Racecourse**
XXXXXX

Case studies.



Mercia School, Sheffield
XXXXX

Why Furnitubes.

- **Made in the UK**
our factory is based in Kent, so expect faster leadtimes and no supply chain delays
- **Easy to maintain + low labour costs**
we make sure that fixing points are easily accessible so slats and brackets can be changed easily when damaged
- **Modular solutions**
our ranges are modular and customisable, seating and planters can be easily combined, be creative without blowing the budget
- **Our approach**
we take a considered approach to design, it's not just about the end product. We take everything in the process into consideration, we are collaborative and we are committed to producing products that improve our environment & keep people safe.



Our Process.

- **Get in touch** – it's as simple as that, give us a call or drop us an email, we're happy to help whatever the medium!
- **Collaborate** – Depending on your needs, you might not actually need us at this stage, that's the beauty of our modular ranges – they're designed with you in mind, so you can specify with ease. Nevertheless, we are here for you if you do – our design team are always on hand to discuss the nitty gritty of your project.
- **Specification** – This is where our team of experts take the wheel and help you with sketches, CADs and more to help you specify our products as easily as possible.
- **Production + delivery** – all of our products are designed and manufactured in the UK allowing us to give you shorter lead times. With a dedicated project manager keeping you in the loop, you can trust everything is in hand.

