

Concrete Seating.

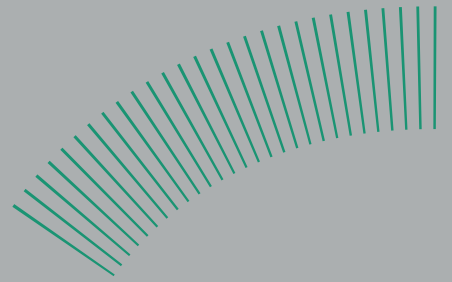

furnitubes
shaping outdoor spaces

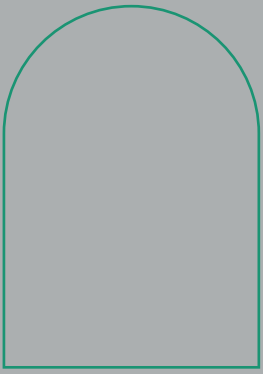

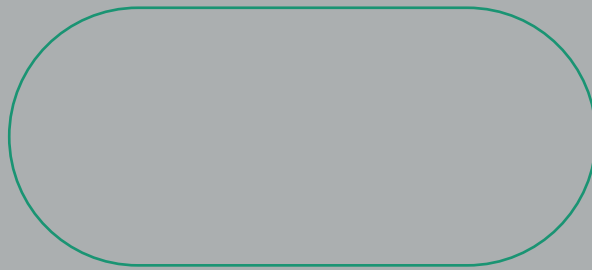
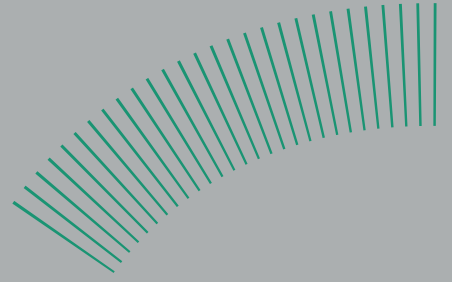
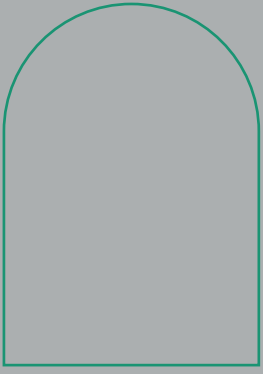

Concrete Seating.

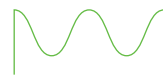
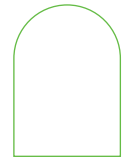

Welcome to Furnitubes' new concrete seating product brochure which includes long-standing favourites, many with updated features, and introduces an extensive range of new products.

Here are just some of the ways our concrete seats can benefit your scheme:

- Durable construction - concrete offers optimum strength to withstand the rigours of daily use and provide maximum product longevity
- Heavy weight and low recyclable value - meaning the products are far less susceptible to theft than those made of metal
- A wide range of standard colours are available to complement the surrounding paving and other materials on your scheme, with special mixes available to order

Blyth Range.

Unique features of the Blyth MK 2 Range

Ideal for demanding urban environments, the Blyth is a long-standing favourite and an increasingly popular choice from Furnitubes' extensive range of concrete seating products. The Blyth MK 2 introduces a number of improvements and new features, including:

- 3 size units
- Available in a wide selection of concrete mixes and finishes
- Solo units for stand-alone situations
- End and mid units to allow longer continuous runs
- Radiused edges for improved comfort for users
- A shallow-domed top to aid water run-off
- Anti-skate device options

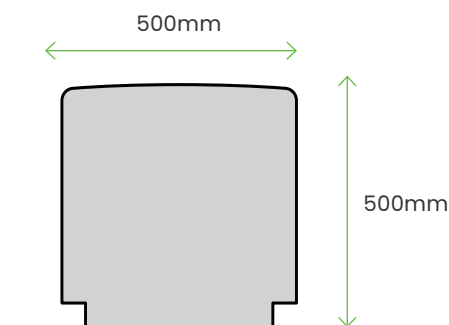

Cross sectional profile
Common to all Blyth products

Standard options

The standard range of bench options comprises the following:

- **Solo units (Cube, 1m & 2m)**
- **End units (1m & 2m)**
- **Mid units (1m & 2m)**

All models have a 50 x 50mm recess around the base of the bench as indicated by the dashed lines on the illustrations.

For continuous seating runs comprising multiple units, adjacent units can be simply butted up to each other as a dry-fit, or jointed using a fibreboard spacer with the joint filled with a mastic or mortar sealant. Please contact our Design Department to discuss these options in more detail

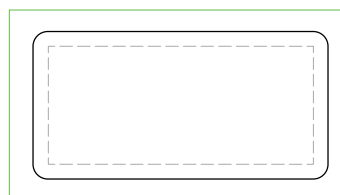

Solo unit:
Rounded corners both ends.
Suitable as stand-alone units only.

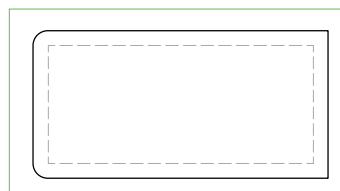

End unit:
Rounded corners one end;
square-faced one end.
Used as end modules on multiple unit seating runs.

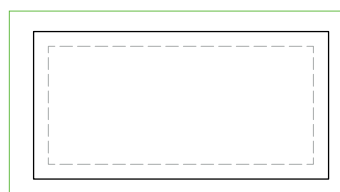

Mid unit:
Square-faced both ends.
Used as central modules on multiple unit seating runs.

Anti-skate devices

Robust concrete products such as the Blyth range of benches are particularly attractive to skateboarders as these heavy products have long straight edges at a convenient height to 'grind' along.

To reduce the risk of damage from skateboard grinding, we offer an anti-skate device - a stainless steel oval ball with a welded stud, permanently secured into drilled holes in the bench with an epoxy resin - as a standard addition on this range.

For 1m and 2m benches we recommend anti-skate devices are positioned as shown below. In our experience, the smaller cube units are too short to attract skaters, but anti-skate devices can be added to these products if required.

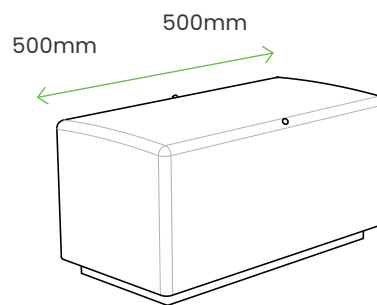

BLYTH 1M
1 ball on each long side

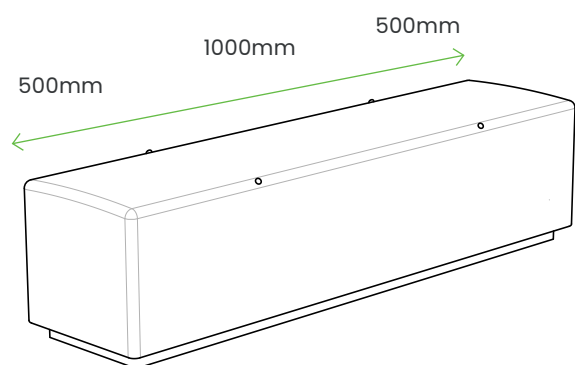

BLYTH 2M
2 balls on each long side



Led Lighting for Blyth Range

When Blyth concrete benches are installed directly onto the paving and the ground level recess is clearly visible, this offers the opportunity to include LED lighting strips as decorative features that emphasise the seating at night and spread a localised wash of light on the surrounding paving.

Lighting can be added to one or both long sides of the 1m and 2m Blyth

benches, and on one or opposite sides of the Blyth cube.

The LED light source can be supplied in a variety of colours, and sits behind a frosted white acrylic cover that allows the coloured light to diffuse through.

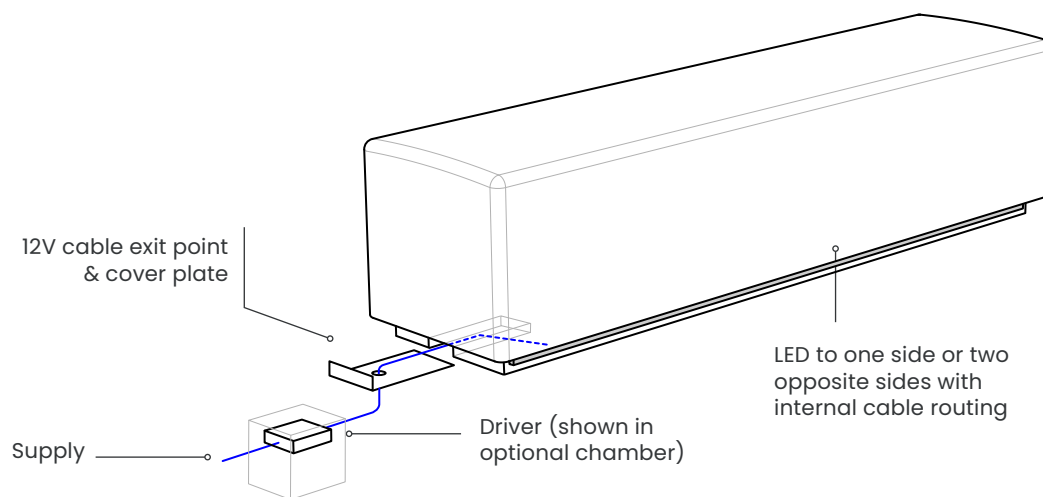

Discrete and robust fittings

The LED light source is housed in a robust aluminium extrusion with a frosted acrylic cover to diffuse the light.

12V cable(s) run internally between the LEDs and their exit point from the bench, and can be supplied up to 4m long to allow for remote above-ground connection to an IP67-rated driver unit and a 240V supply.

Alternatively, the driver can be placed in an IP68-rated ground chamber. Where there are adjacent lit benches in close proximity, the lighting can be connected to a single driver unit. A plastic cover plate fits over the ground level recess at the end of the bench to hide the cable exit point.



The LED extends close to the end of the ground level recess and is securely fitted to the bench at a position which minimises the likelihood of accidental damage.

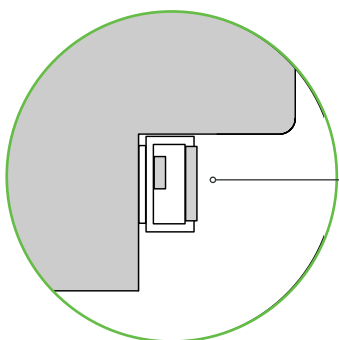

Enlarged cross section showing LED housed in aluminium extrusion with acrylic diffuser



Blyth Range.

Blyth Cube

500 x 500mm cube, wgt: 300kg

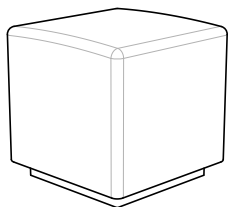

Options

- Range of standard colour mixes and finishes

SOLO UNIT

BLS6

Blyth 1M

1000mm length, wgt: 600kg

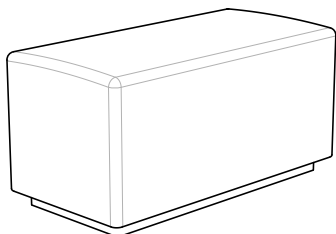

Options

- Range of std mixes / finishes
- Anti-skate devices
- Ground level LED lights

SOLO UNIT

BLR100SO

END UNIT

BLR100EN

MID UNIT

BLR100MD

Blyth 2M

2000mm length, wgt: 1200kg

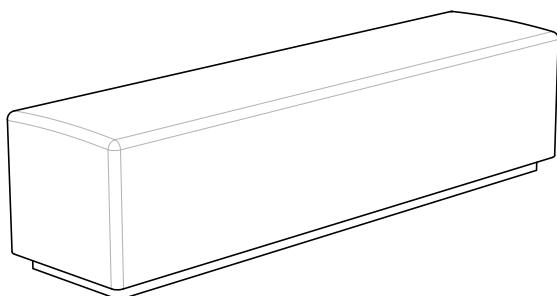

Options

- Range of standard colour mixes and finishes
- Anti-skate devices

SOLO UNIT

BLR200SO

END UNIT

BLR200EN

MID UNIT

BLR200MD

Note: All products illustrated on this page are 'Solo' units

Installation.

Handling and installation

A 50 x 50mm recess to the lower edge is a design feature on all Blyths. This facilitates on-site handling by providing an edge against which lifting straps can be located and tensioned.

The recess also allows two basic installation options as shown below, the advantages and disadvantages of which are discussed in detail. A third

option is to install the bench so that the base sits below the finished paving level, as for option 1 but to a lesser depth, meaning the height of the exposed recess is reduced.

Please note that the faces of the recess are left 'as-struck' and not finished to match the main body of the bench.

Option 1:

Base of bench set below finished paving level

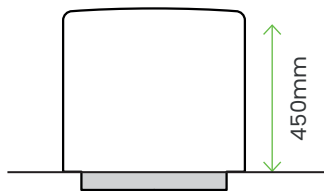

Advantages

- Benches can be set true level
- Any damage to lower edge of the recess (caused during handling) is hidden beneath the paving
- Paving set below recess overhang so any untidy edges to paving can be hidden

Disadvantages:

- Requires ground excavation
- Not suitable for products with recess-mounted lighting

Option 2:

Base of bench set on top of finished paving

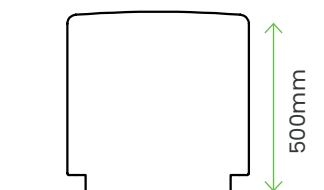

Advantages

- No ground excavation
- Shadow gap visually lifts bench product off the paving
- Suitable for products with recess-mounted lighting

Disadvantages:

- Product will not be true plumb if paving isn't level
- Any untidy paving abutting the recess is visible

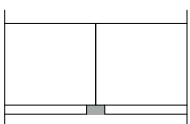

When multiple bench units are directly abutted and set on top of the paving, there will be a 100mm gap between the recessed faces. This can be left as is or the gaps filled with matching coloured 'plugs'.

Mesa Range.

Angular modules with infinite combinations

Mesa is a range of concrete block seating based on a square section being 'sliced' by 30 / 60 degree compound angle cuts, to produce a range of dynamic angular forms which can be used as stand-alone benches or combined as multiple units for short or long straight runs.

The range comprises 8 interchangeable modules - 2 units offer a minimum seating surface of 500mm (suitable for 1 person), 4 are at 1000mm (2 person) and 2 units at 1500mm long (3 person).

The 500mm and 1000mm units are angled at one end and square-faced at the other to offer the option of squaring off the ends of seating runs when multiples units are abutted.

A new addition to the range is the 120° elbow, which when combined with standard modules changes in the directions of seating. All Mesa modules are offered in our standard range of concrete colour mixes and finishes, which can be mixed and matched where they are used as multiples.

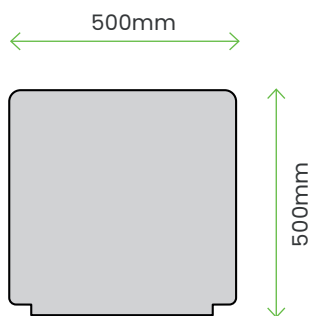

Cross sectional profile
Common to all Mesa products

Standard options

The 8 standard modules in the Mesa range are categorised by:

- The minimum number of people the bench unit will accommodate
- The end forms of the bench, i.e. square, acute or obtuse

End forms are coded as follows:

- **A:** Acute form, handed left
- **B:** Obtuse form, handed left
- **C:** Acute form, handed right
- **D:** Obtuse form, handed right
- **S:** Square form

For continuous run straight seating walls, the following end codes should be paired:

- **A + B**
- **C + D**
- **S + S**

Any other pairings will result in large gaps between abutting units, or deviation from a straight alignment to the seating wall.



Combination Options.

With individual modules featuring various combinations of acute and obtuse angled and square ends, directly abutting compatible adjacent modules can produce a wide variety of different forms for paired combinations or longer continuous seating walls, as shown in the examples below.

Note, only straight line runs are achievable in the Mesa range, although corners can be created by abutting two square-ended modules; angular changes in direction cannot be achieved as this results in overlapping planes and voids between adjacent modules.

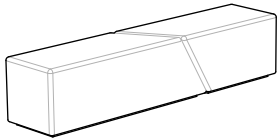

Both ends square
e.g. MES2SB + MES2SA

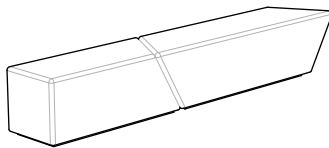

One end square, one end angled
e.g. MES2SD + MES3AC

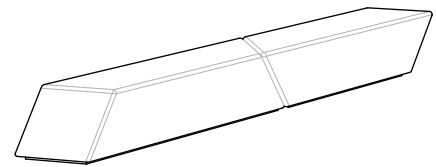

Both ends angled
e.g. MES3DB + MES3AC

Mixings colours & finishes

Further variation can be achieved by using contrasting colour mixes and finishes to visually accentuate the different modules and the angularity of the joints between, as shown in the example here.

Shown here are the standard colour and finish options. Special mixes for specific schemes can be created for larger quantity orders.

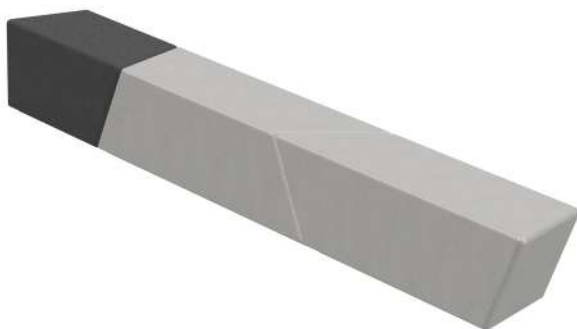

ACID ETCHED

DRESSED

WHITE



LIGHT GREY



DARK GREY











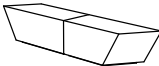

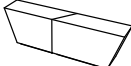
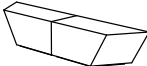
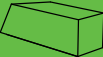
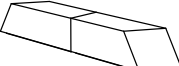
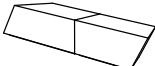
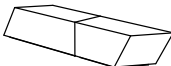

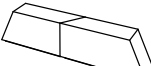
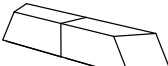
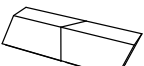

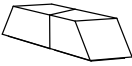
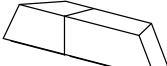
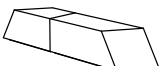
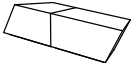
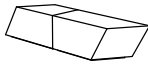
Paired square-ended modules.

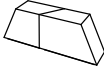
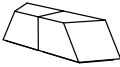
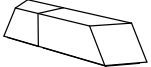
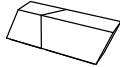
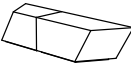
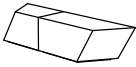
Mixing different modules in multiple paired combinations can create many visually interesting variations, whilst still retaining a sense of coordination when used across a single scheme.

This matrix shows all possible pairing combinations of 1 and 2 person modules

when the square ends are placed in 'back-to-back' arrangements, i.e. square face to square face. When used as pairs alone in these combinations, all benches will have compound angled end faces - of either / or acute and obtuse forms.

 <p>Square / Acute 2 person right MES2SC</p>						 <p>2520mm o/a seats 4</p>
 <p>Square / Acute 2 person left MES2SA</p>					 <p>2520mm o/a seats 4</p>	 <p>2520mm o/a seats 4</p>
 <p>Square / Obtuse 2 person right MES2SD</p>				 <p>3030mm o/a seats 4</p>	 <p>2775mm o/a seats 4</p>	 <p>2775mm o/a seats 4</p>
 <p>Square / Obtuse 2 person left MES2SB</p>			 <p>3030mm o/a seats 4</p>	 <p>3030mm o/a seats 4</p>	 <p>2775mm o/a seats 4</p>	 <p>2775mm o/a seats 4</p>
 <p>Square / Obtuse 1 person left MES1SD</p>		 <p>2030mm o/a seats 3</p>	 <p>2530mm o/a seats 3</p>	 <p>2530mm o/a seats 3</p>	 <p>2275mm o/a seats 3</p>	 <p>2275mm o/a seats 3</p>
 <p>Square / Obtuse 1 person left MES1SB</p>	 <p>2030mm o/a seats 2</p>	 <p>2030mm o/a seats 2</p>	 <p>2530mm o/a seats 3</p>	 <p>2530mm o/a seats 3</p>	 <p>2275mm o/a seats 3</p>	 <p>2275mm o/a seats 3</p>
<p>REAR MODULES ↗</p> <p>↘ FRONT MODULES</p>	 <p>Square / Obtuse 1 person left MES1SB</p>	 <p>Square / Obtuse 1 person left MES1SD</p>	 <p>Square / Obtuse 2 person left MES2SB</p>	 <p>Square / Obtuse 2 person right MES2SD</p>	 <p>Square / Acute 2 person left MES2SA</p>	 <p>Square / Acute 2 person right MES2SC</p>

A change of direction.

The 120° 'elbow' is the latest addition to the Mesa range, with square vertical faces at both ends meaning it can be directly abutted to any of the 6 standard Mesa modules with square ends. This single additional module to the range opens up a whole new raft of configuration possibilities, including those shown below.

Multiple elbows can be used on single seating runs; if all in the same direction the seating will begin to create enclosures and if used alternately in opposite directions will form dynamic angular kinks.

1 Elbow

Adding just one elbow introduces two angled arms to a seating wall, and creates a sense of enclosure in the process.

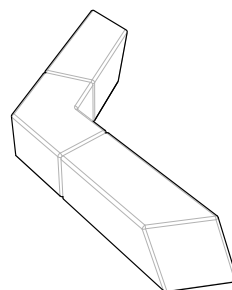

Example
1 each of MES120,
MES2SC, MES2SD

2 Elbows

In a single run, used in opposite directions, two elbows create a distinctive kink to the seating line.

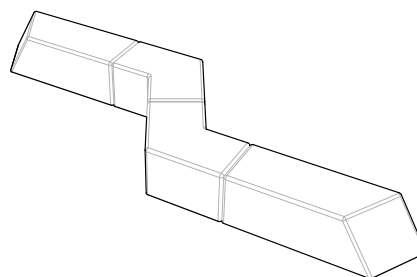

Example
MES120 x 2
MES2SB
MES2SD

3 Elbows

Adding more elbows creates more dynamic layouts, as shown here with three elbows in alternate directions creating a zig-zag.

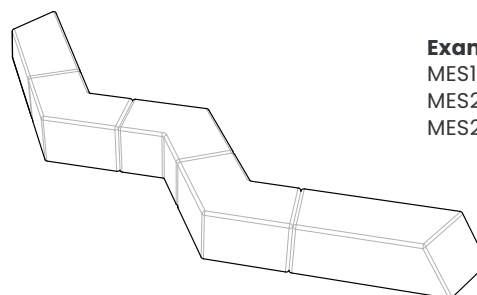

Example
MES120 x 3
MES2SB
MES2SD

Mesa Range.

Mesa - Square + Acute ended

1260 x 500 x 500mm, wgt: 600kg

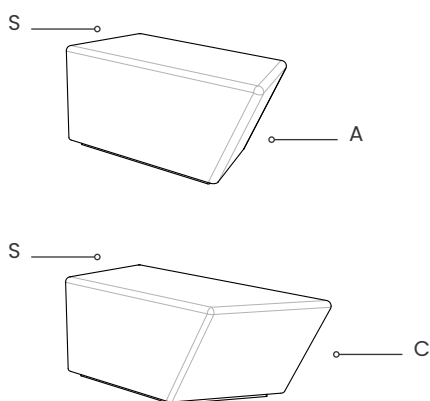

Options

- Range of standard colour mixes and finishes

**2 PERSON UNIT
(TOP ILLUSTRATION)**

MES2 SA

**2 PERSON UNIT
(BOTTOM ILLUSTRATION)**

MES2 SC

Mesa Acute ended

2020 x 500 x 500mm, wgt: 900kg

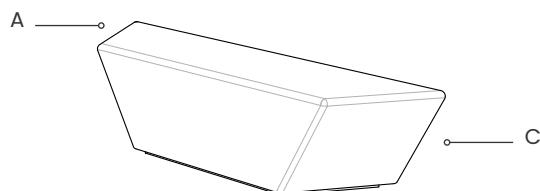

3 PERSON UNIT

MES3 AC

Mesa Obtuse ended

2530 x 500 x 500mm wgt: 1200Kg

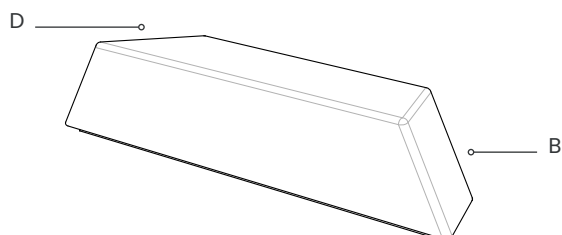

3 PERSON UNIT

MES3DB

Note: All products illustrated on this page are 'Solo' units

Mesa Range.

Mesa - Square + Obtuse ended

760 x 500 x 500mm, wgt: 450kg

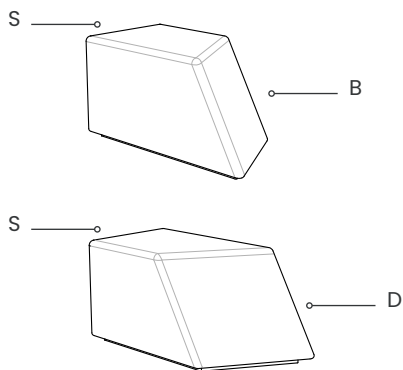

Options

- Range of standard colour mixes and finishes

1 PERSON UNIT
(TOP ILLUSTRATION)

MES1 SB

1 PERSON UNIT
(BOTTOM ILLUSTRATION)

MES1 SD

Mesa - Square + Obtuse ended

1510 x 500 x 500mm, wgt: 750kg

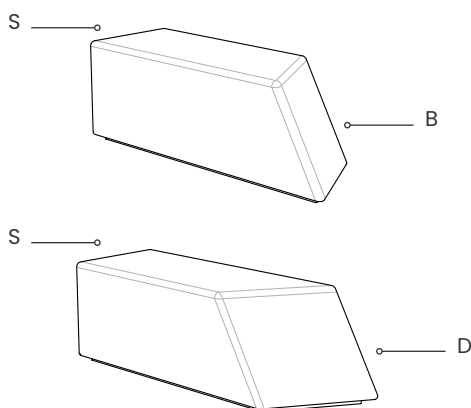

2 PERSON UNIT
(TOP ILLUSTRATION)

MES2 SB

2 PERSON UNIT
(BOTTOM ILLUSTRATION)

MES2 SD

Mesa - 120° ELBOW, SQUARE ENDED

1050 x 855 x 500mm high, wgt: 650kg

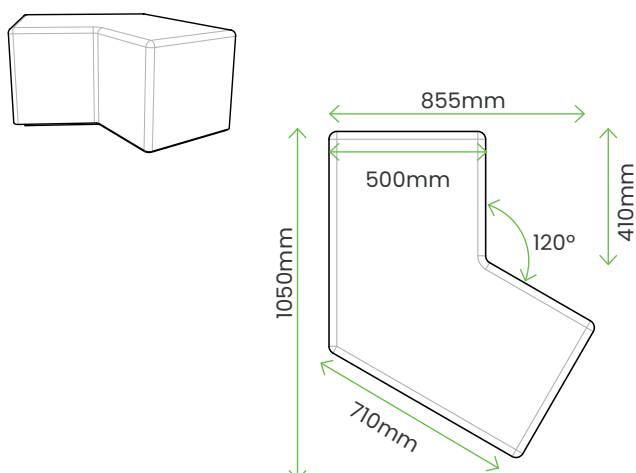

Options

- Range of standard colour mixes and finishes

2 / 3 PERSON UNIT

MES2 120

Note: All products illustrated on this page are 'Solo' units

Installation.

Handling and installation

A 25mm high x 50mm deep recess to the lower edge is a design feature on all Mesa modules.

This facilitates off-loading and on-site handling by providing an edge against which lifting straps can be located and

tensioned. Alternatively, the flat sides suit the use of a grab lift or the flat top is suited to the use of a vacuum lift.

The recess also allows two installation options as shown below.

Option 1:

Base of bench set below finished paving level

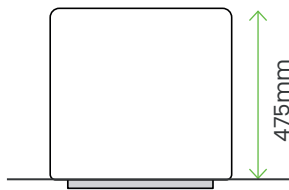

Advantages

- Benches can be set true level
- Any damage to lower edge of the recess (caused during handling) is hidden beneath the paving
- Paving set below recess overhang so any untidy edges to paving can be hidden

Disadvantages:

- Requires ground excavation

Option 2:

Base of bench set on top of finished paving

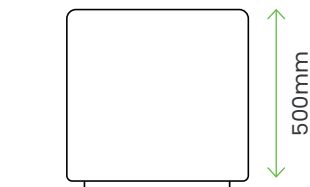

Advantages

- No ground excavation
- Shadow gap visually lifts bench product off the paving

Disadvantages:

- Product will not be true plumb if paving isn't level
- Any untidy paving abutting the recess is visible

Concrete Seating.

Colour / finish options

Concrete seating ranges are available in three standard mixes, with further finish options as summarised below. Custom mixes can be offered for large volumes.

Dressed finish

A flat matt surface with minimal dressing of the 'as struck' cast surfaces.

Anti-graffiti coating

Various proprietary coatings are available; please speak to our technical department for further information on options.

Acid etched finish

A very finely-textured surface achieved by washing with an acidic solution to reveal the fines and lightly expose the aggregates.

Sealant

A matt 'consolidator' sealant is applied as standard to Dark Grey FCH1 mix.

Samples

Swatches shown should be considered indicative only. Please contact us to obtain samples to ensure that you specify and order the desired colour mix and finish.

Standard colour options

White

Ref. FWHI

FWHI comprises a mix of white cement and white limestone. Where the aggregates are revealed by etching, products take on a more grey / cream appearance.

Light Grey

Ref. FGRI

FGRI is a premium mix of grey and white cements and fines, with white limestone aggregates designed to achieve a light grey colour and fine finish specifically designed for external furniture.

Dark Grey

Ref. FCH1

FCH1 is a mix of grey cement, black sand and grey basalt aggregates. A waterproof matt sealant application is standard on all finishes.

ACID ETCHED



DRESSED



ACID ETCHED



DRESSED



ACID ETCHED



Core Range.

Core Seating blocks and tables

The Core concrete range provides simple yet elegant seating in a variety of different sizes and forms. The Core range consists of stand-alone units which can be used to form clusters of informal seating and tables available in a wide range of standard concrete colours and finishes, generally all with rounded edges for added comfort and to reduce the risk of chipping.



Circular concrete seating block

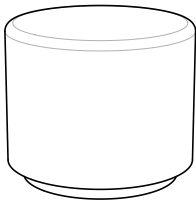

Ø600MM X 500MM HIGH
50MM X 50MM RECESS
WEIGHT: 336KG

COC600R

Square concrete seating block

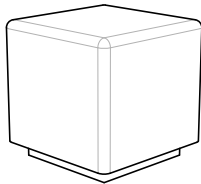

450MM X 450MM X 450MM HIGH
50MM X 50MM RECESS
WEIGHT: 215KG

COS450R

Square concrete seating block

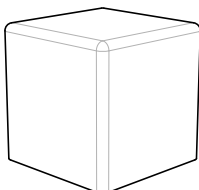

450MM X 450MM X 450MM HIGH
WEIGHT: 215KG

COS450

Square concrete seating block

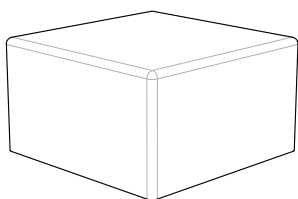

Options

- Range of standard concrete mixes and finishes
- 1000mm x 1000mm x 450mm high version

**800MM X 800MM X 450MM HIGH
WEIGHT: 690KG**

COS800

Rectangular concrete seating block

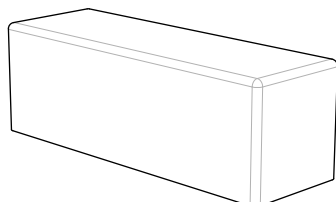

Options

- Range of standard concrete mixes and finishes
- Anti-skate devices

**1350MM X 450MM X 450MM HIGH
WEIGHT: 655KG**

COR135

Rectangular concrete seating block

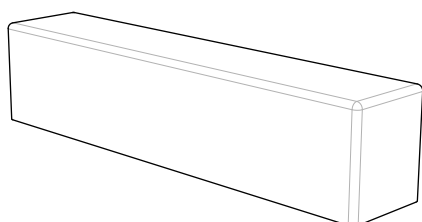

Options

- Range of standard concrete mixes and finishes
- Anti-skate devices

**2000MM X 400MM X 450MM HIGH
WEIGHT: 864KG**

COR200

Rectangular concrete seating block

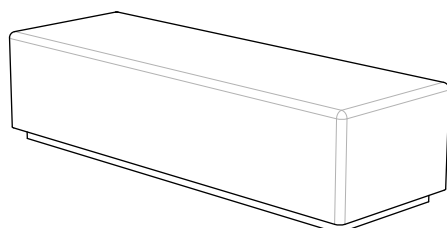

Options

- Range of standard concrete mixes and finishes
- Anti-skate devices

**1800MM X 600MM X 450MM HIGH
50MM X 50MM RECESS
WEIGHT: 1100KG**

COR180

Fortis Range.

Modular concrete & timber seating

Fortis is a new seating product designed to offer an adaptable range of configuration options from a limited number of standard components. The concrete plinth is the central component of the range, onto which timber-slatted seat and bench platforms can be mounted. The concrete plinth is also useable as a seating platform on its own. Fixing points are pre-fitted to all concrete plinths, regardless of whether or not they are all needed in the initial assembly, thereby allowing seat platforms to be easily repositioned or replaced at a later date. Fortis is ideal for long

continuous seating 'walls', where the concrete plinths allow informal (slightly lower level) seating and the timber seating platforms offer greater comfort. Bench platforms (without backrests) allow access from both sides and seat platforms can be fixed with the backrest to either side, to allow dual orientation on a single seat.

Set out in variable configurations on the same scheme, the Fortis gives the impression of a purpose-made design, but is all achievable with a small number of common components which offer cost-effective seating solutions.

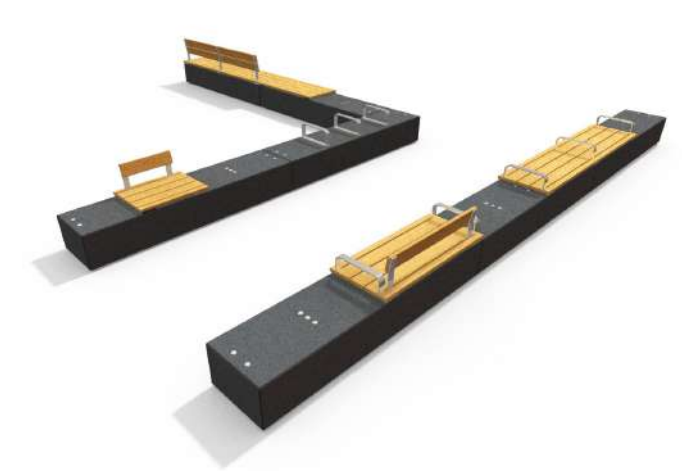

Standard options

The standard Fortis range includes the following options:

- **Seats** (with backs) & benches (without backs)
- **Seat platforms** - to suit 1-4 person seating positions
- **Timber profiles** - 3 size options
- **Armrests** - linked to seat platform or independent
- **Backrests** - high or low
- **Multiple assemblies** - for continuous seating walls

Continuous seating walls

For continuous seating walls comprising multiple seats / benches, adjacent concrete plinths can be directly abutted and seating platforms can be designed to bridge across adjoining concrete plinths. Plinths can be placed independently as a dry-fit joint, or the joint can be filled with a mastic or mortar sealant. Please contact our Design Department to discuss these options in more detail.

Side-to-side slat arrangements*

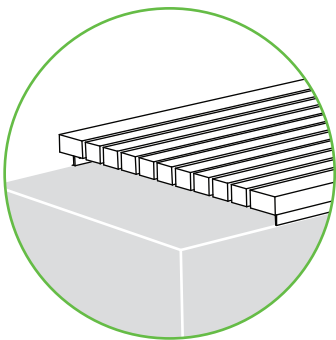

Small timbers
40mm wide

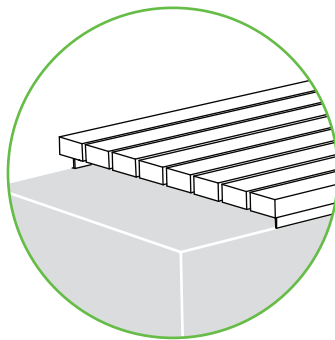

Medium timbers
65mm wide

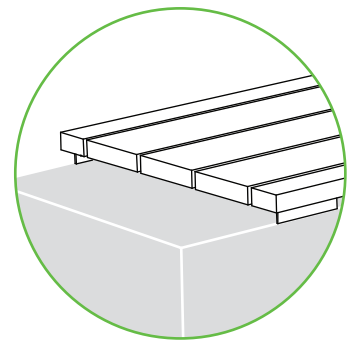

Large timbers
140mm wide

* All side-to-side layouts use a 65mm wide timber for front & back slats.



Fortis Range.

- Bench / seat with concrete plinth and timber seating platform on steel supports, with large timber slats in side-to-side arrangement
- 2540mm long x 590mm deep concrete plinth, weight: 1,400kg (concrete only)

Options

- Range of standard concrete mixes and finishes
- Seat platform support / armrest / backrest support metalwork in galvanised finish where no arms included
- Seat platform support / armrest / backrest support metalwork in triple process coating (PPC) finish where arms are included

Benches

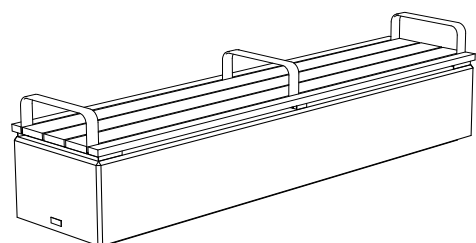
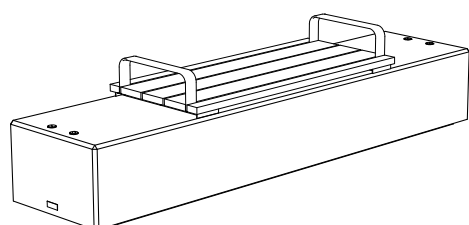
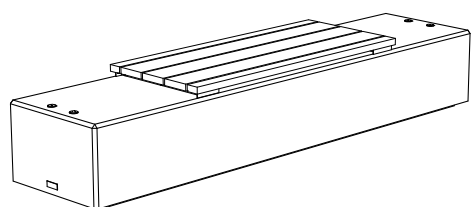

Seats

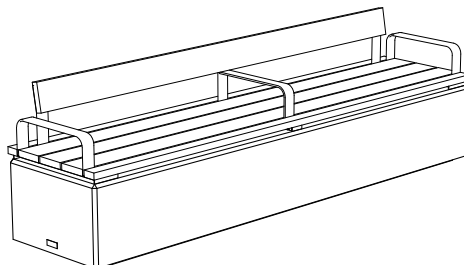
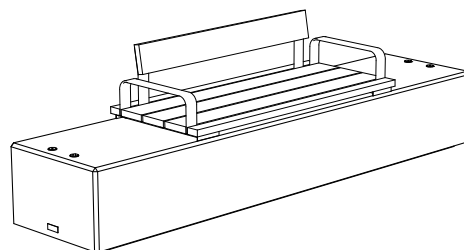
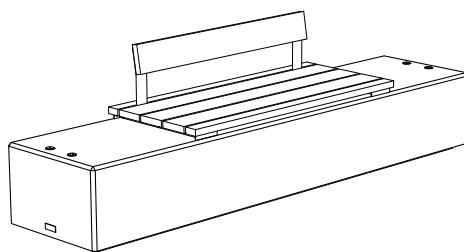

BENCHES

BENCH WITH 2-PERSON PLATFORM (NO ARMS)	FTB22L
BENCH WITH 2-PERSON PLATFORM + ARMS	FTB22LC
BENCH WITH 4-PERSON PLATFORM + ARMS	FTB4LS

SEATS

SEAT WITH 2-PERSON PLATFORM (NO ARMS)	FTS22LL
SEAT WITH 2-PERSON PLATFORM + ARMS	FTS22LLC
SEAT WITH 4-PERSON PLATFORM + ARMS	FTS4LLS

Handling & installation

For ease of transportation and handling, and to minimise the chances of damage prior to installation, Fortis seating is supplied in component form for on-site assembly. The concrete plinth is lifted and lowered into position by using straps (not supplied) which can be tensioned against the recess to the underside of the bench. The plinth can be placed directly on top of the ground, or a recess can be formed in the paving into which the inset base is located.

Seat and bench platforms are supplied pre-assembled and are fitted to the plinth with simple bolted connections accessed between the timbers. The timbers are fixed to the steel framework with discrete fixings, which can be removed if the timbers need to be replaced in future. Given their heavy weight, Fortis seats / benches are generally left free-standing.

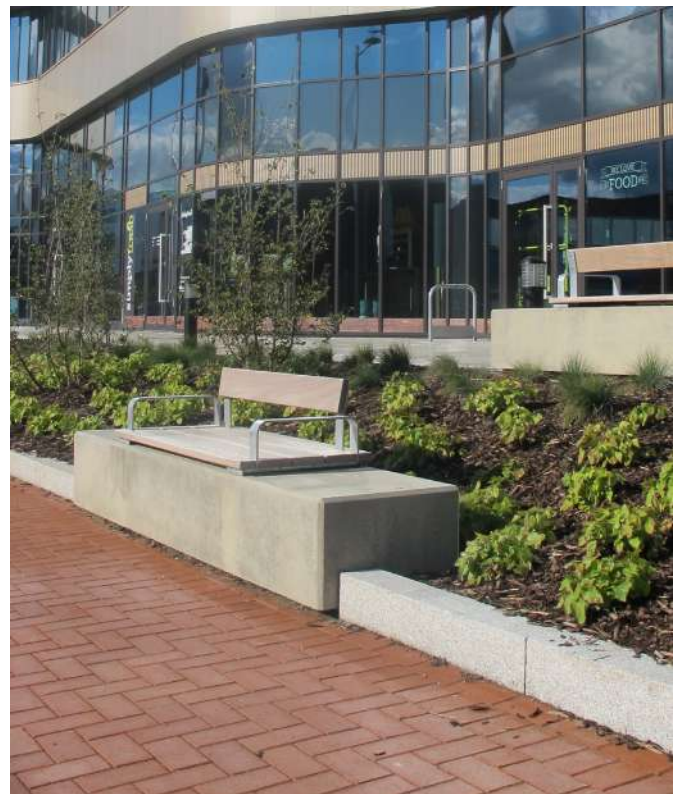

Why Furnitubes.

- **Made in the UK**
our factory is based in Kent, so expect faster leadtimes and no supply chain delays
- **Easy to maintain + low labour costs**
we make sure that fixing points are easily accessible so slats and brackets can be changed easily when damaged
- **Modular solutions**
our ranges are modular and customisable, seating and planters can be easily combined, be creative without blowing the budget
- **Our approach**
we take a considered approach to design, it's not just about the end product. We take everything in the process into consideration, we are collaborative and we are committed to producing products that improve our environment & keep people safe.



Our Process.

- **Get in touch** – it's as simple as that, give us a call or drop us an email, we're happy to help whatever the medium!
- **Collaborate** – Depending on your needs, you might not actually need us at this stage, that's the beauty of our modular ranges – they're designed with you in mind, so you can specify with ease. Nevertheless, we are here for you if you do – our design team are always on hand to discuss the nitty gritty of your project.
- **Specification** – This is where our team of experts take the wheel and help you with sketches, CADs and more to help you specify our products as easily as possible.
- **Production + delivery** – all of our products are designed and manufactured in the UK allowing us to give you shorter lead times. With a dedicated project manager keeping you in the loop, you can trust everything is in hand.

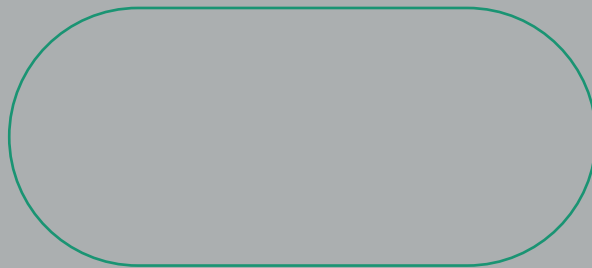
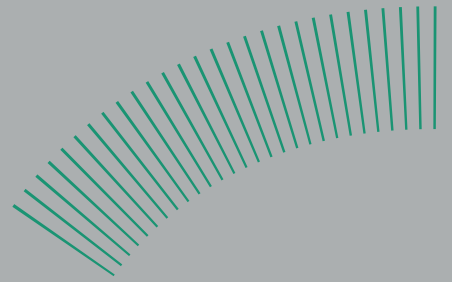
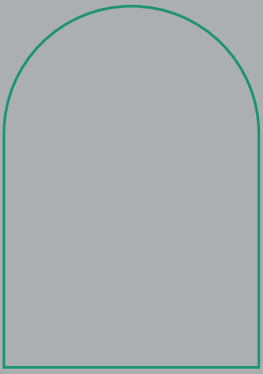
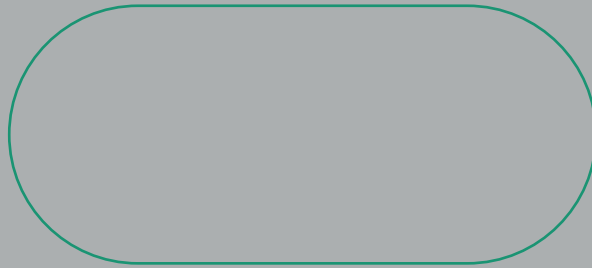
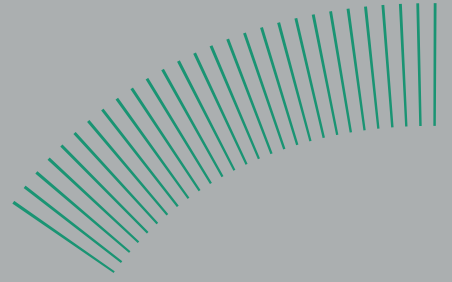
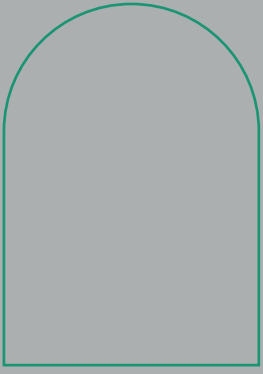



Furnitubes



Furnitubes



Furnitubes International UK

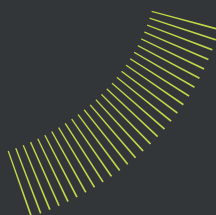

furnitubes
shaping outdoor spaces

T: +44 (0)20 8378 3200
E: sales@furnitubes.com
www.furnitubes.com